



# Rettungsdatenblätter

## Cartes de sauvetage

## Carte di salvataggio

Diese Rettungsdatenblätter dienen ausschliesslich Einsatzkräften auf dem Gebiet der technischen Hilfeleistung.

Alle auf den Rettungsdatenblättern enthaltenen Informationen sind ausschliesslich für Fahrzeuge, welche für den europäischen Markt bestimmt sind. In den Rettungsdatenblättern ist immer die maximal mögliche Ausstattung der Fahrzeuge gezeigt.

Rechtsgelenkte Fahrzeuge können Bauart bedingt abweichen.

Fahrzeuge und Ausstattungsvarianten unterliegen ständigen Änderungen. KIA behält sich das Recht vor, Konstruktionen und Spezifikationen jederzeit ohne Ankündigung und ohne Übernahme eine Verpflichtung auslaufen zu lassen oder zu ändern.

Hinweis:

Diese Informationen sind ausschliesslich für geschulte Einsatzkräfte und nicht für Endkunden, Werkstätten und Händler bestimmt.

---

Ces cartes de sauvetage sont exclusivement destinées aux services de secours dans le domaine de l'assistance technique.

Toutes les informations contenues dans les cartes de sauvetage ne sont valables que pour les véhicules destinés au marché européen. Les cartes de sauvetage montrent toujours l'équipement maximal possible des véhicules.

Les véhicules avec le volant à droite peuvent différer des autres du fait de leur construction.

Les véhicules et les niveaux de finition sont soumis à des modifications constantes. KIA se réserve le droit de mettre fin ou de modifier à tout moment les constructions et les spécifications sans préavis et sans assumer aucune obligation.

Observation :

Ces informations sont exclusivement destinées aux services de secours formés et pas aux clients finaux, ateliers et agents.

---

Queste carte di salvataggio sono esclusivamente destinate ai servizi di soccorso. Tutte le informazioni contenute dentro la carta di salvataggio sono valide solo per le vetture destinate al mercato europeo. Le carte di salvataggio mostrano sempre l'equipaggiamento massimo possibile delle vetture.

I veicoli con il volante a destra possono differenziare dalla loro costruzione.

I veicoli e le varianti d'equipaggiamento vengono costantemente modificate. Kia si riserva il diritto di modificare le costruzioni e le specifiche in qualsiasi momento senza preavviso e senza assumersi l'obbligo di scadenza o cambiamento.

Osservazione:

Queste informazioni sono esclusivamente destinate per il servizio di soccorso e non per clienti, officine e concessionari.



## Inhalt / Contenu / Contenuto

|   |    |
|---|----|
| Picanto (SA) 2004-2011.....                                 | 4  |
| Picanto (TA) ab/dès/dal 2011 3- Türer/Portes/Porte .....    | 5  |
| Picanto (TA) LPG ab/dès/dal 2011 3- Türer/Portes/Porte..... | 6  |
| Picanto (TA) ab/dès/dal 2011 5- Türer/Portes/Porte .....    | 7  |
| Picanto (TA) LPG ab/dès/dal 2011 5- Türer/Portes/Porte..... | 8  |
| Rio (JB) 2005-2011.....                                     | 9  |
| Rio (JB) ab/dès/dal 2011 3- Türer/Portes/Porte .....        | 10 |
| Rio (UB) ab/dès/dal 2011 5- Türer/Portes/Porte .....        | 11 |
| Soul (AM) ab/dès/dal 2009 .....                             | 12 |
| Soul (PS) ab/dès/dal 2014 .....                             | 13 |
| Soul EV (PS EV) ab/dès/dal 2014.....                        | 14 |
| Venga (YN) ab/dès/dal 2010 .....                            | 15 |
| Cerato (LD) 2004-2009.....                                  | 16 |
| Cerato (LD) 2004-2011 5- Türer/Portes/Porte .....           | 17 |
| cee'd (ED) 2007-2012 5- Türer/Portes/Porte .....            | 18 |
| cee'd sw (ED) 2007-2012 Sportswagon .....                   | 19 |
| cee'd (ED) 2007-2012 5- Türer/Portes/Porte .....            | 20 |
| pro cee'd (ED) 2008-2012 3- Türer/Portes/Porte.....         | 21 |
| cee'd (JD) ab/dès/dal 2012 5- Türer/Portes/Porte.....       | 22 |
| cee'd sw (JD) ab/dès/dal 2012 Sportswagon .....             | 23 |
| pro cee'd (JD) ab/dès/dal 2013 3- Türer/Portes/Porte.....   | 24 |









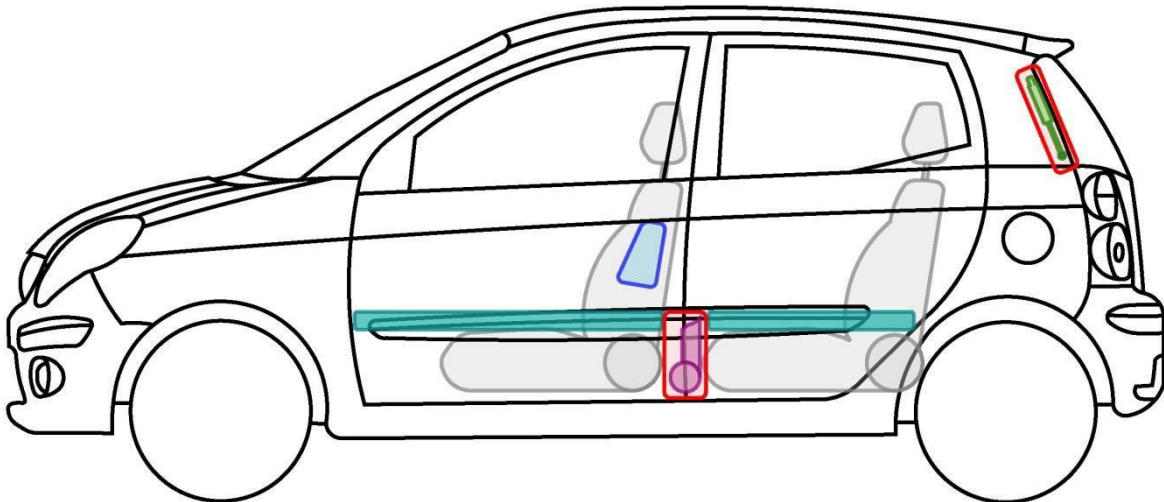
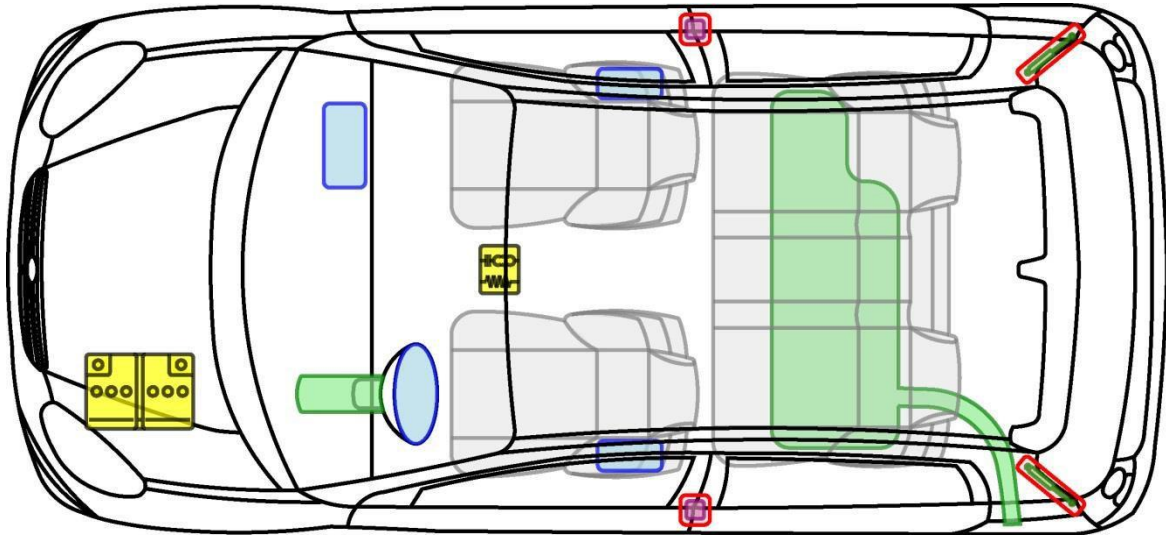

|  |    |
|--|----|
| Magentis (MG) ab/dès/dal 2006 .....      | 25 |
| Opirus (GH) ab/dès/dal 2003.....         | 26 |
| Optima (TF) ab/dès/dal 2012 .....        | 27 |
| Optima (TF) ab/dès/dal 2012 Hybrid ..... | 28 |
| Optima (JF) ab/dès/dal 2016 .....        | 29 |
| Optima (JF) ab/dès/dal 2016 .....        | 30 |
| Carens (UN) 2006-2013.....               | 31 |
| Carens (RP) ab/dès/dal 2013.....         | 32 |
| Niro (DE) ab/dès/dal 2016 Hybrid .....   | 33 |
| Carnival (GQ) 1999-2006 .....            | 34 |
| Carnival (VQ) ab/dès/dal 2006 .....      | 35 |
| Sportage (KM/JES) 2004-2010 .....        | 36 |
| Sportage (SL) ab/dès/dal 2010.....       | 37 |
| Sportage (QL) ab/dès/dal 2016 .....      | 38 |
| Sorento (BL) 2002-2006.....              | 39 |
| Sorento (BL) 2006-2009.....              | 40 |
| Sorento (XM) ab/dès/dal 2009 .....       | 41 |
| Sorento (UM) ab/dès/dal 2014 .....       | 42 |



# Picanto (SA) 2004-2011



### Legende / Légende / Legenda







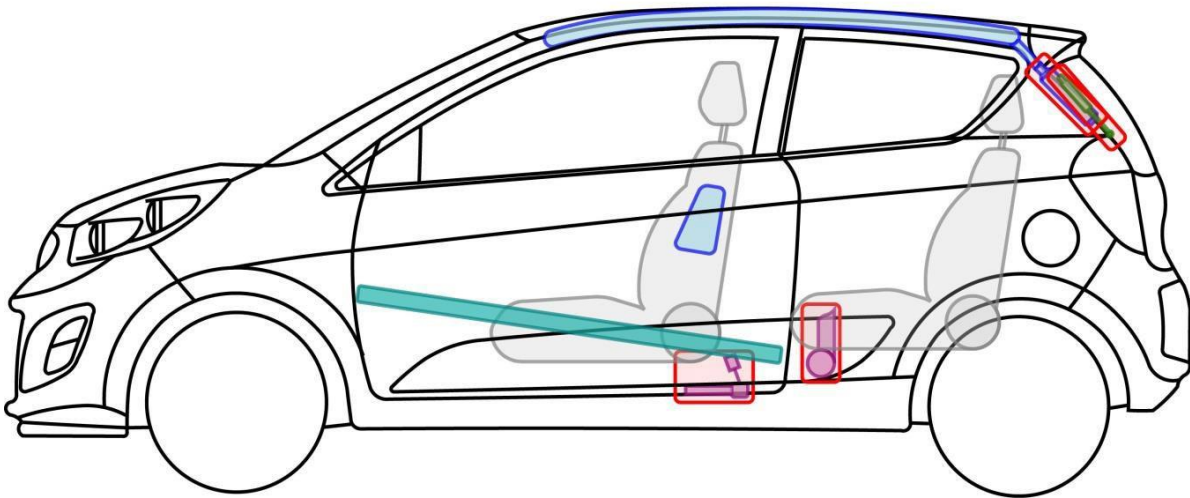
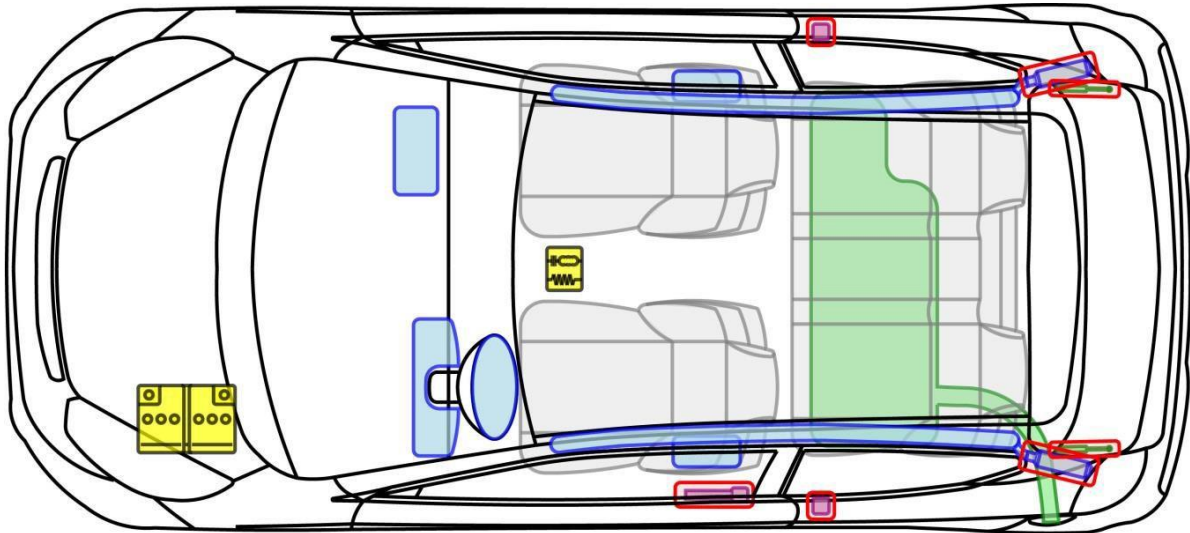

|   |                                       |   |   |   |  |
|---|---------------------------------------|---|---|---|--|
|  | Airbag                                |  | 12V Batterie<br>12V Batterie<br>12V Batteria                            |  | Gasdruckdämpfer<br>Amortisseur à gaz<br>Ammortizzatore a gas         |
|  | Steuergerät<br>ECU<br>Centralina      |  | Karosserieverstärkung<br>Renfort de carrosserie<br>Rinforzo carrozzeria |  | Überrollschutz<br>Arceau de sécurité<br>Protezione anticappottamento |
|  | Gasgenerator<br>Gazogène<br>Gassogeno |  | Gurtstraffer<br>Prétensionneur de ceinture<br>Pretensionatore di carico |  | Kraftstofftank<br>Réservoir de carburant<br>Serbatoio di carburante  |

Picanto



**Picanto (TA)**  
**ab/dès/dal 2011**  
**3- Tüerer/Portes/Porte**











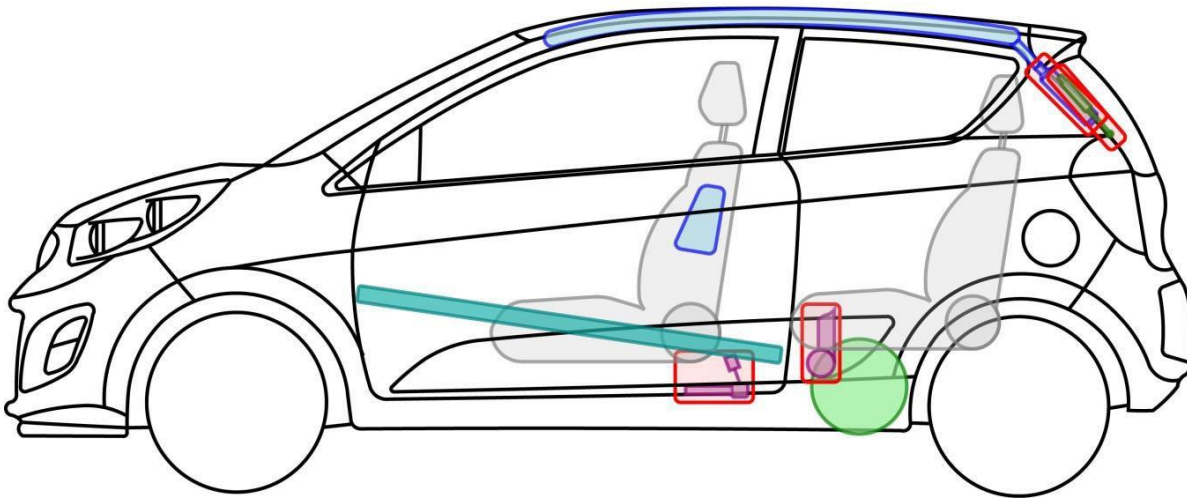
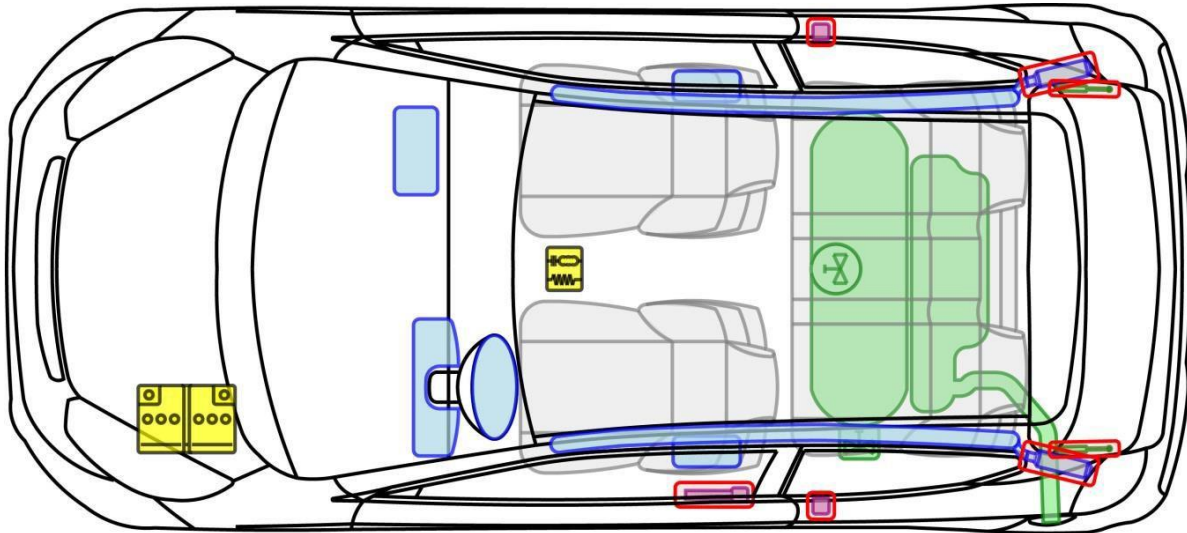

| Legende / Légende / Legenda   |                                       |   |   |   |   |
|---|---------------------------------------|---|---|---|---|
|  | Airbag                                |  | 12V Batterie<br>12V Batterie<br>12V Batteria                            |  | Gasdruckdämpfer<br>Amortisseur à gaz<br>Ammortizzatore a gas        |
|  | Steuergerät<br>ECU<br>Centralina      |  | Karosserieverstärkung<br>Renfort de carrosserie<br>Rinforzo carrozzeria |  | Überrollschutz<br>Arceau de sécurité<br>Protezione anticapottamento |
|  | Gasgenerator<br>Gazogène<br>Gassogeno |  | Gurtstraffer<br>Prétensionneur de ceinture<br>Pretensionatore di carico |  | Kraftstofftank<br>Réservoir de carburant<br>Serbatoio di carburante |

Picanto



**Picanto (TA) LPG**  
**ab/dès/dal 2011**  
**3- Tüerer/Portes/Porte**











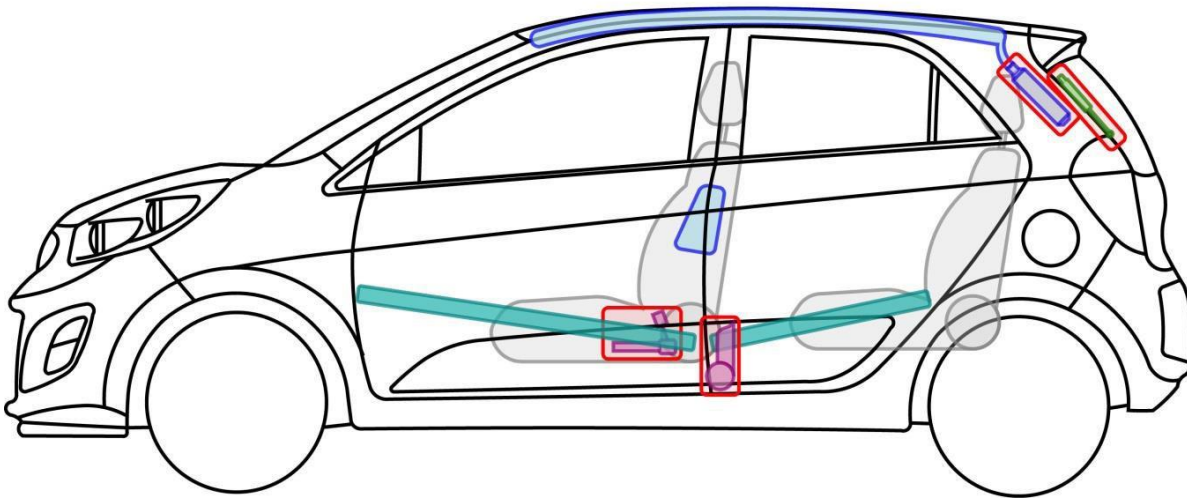
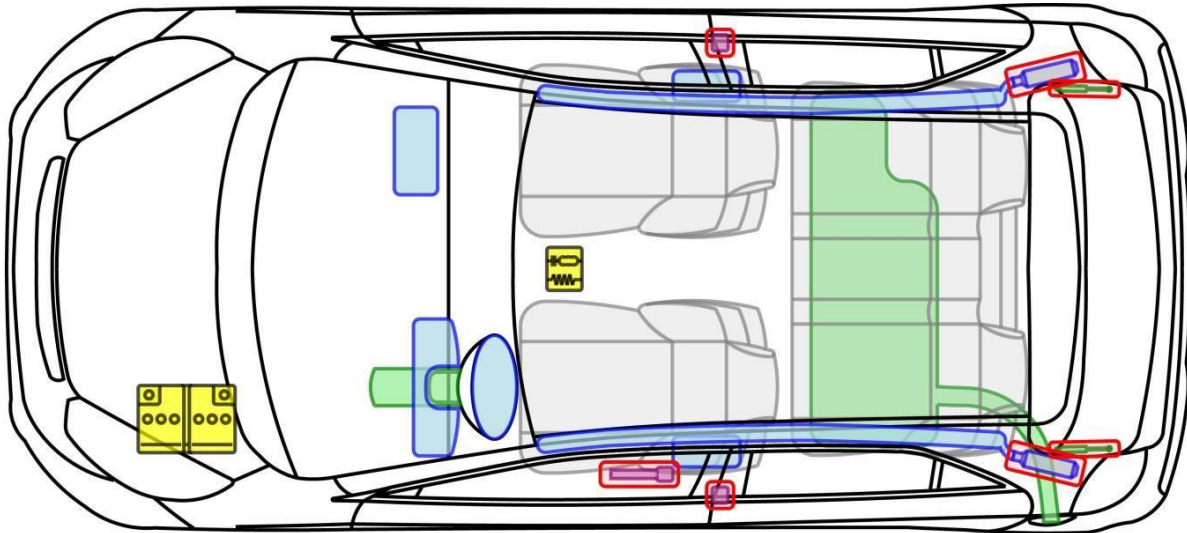

| Legende / Légende / Legenda   |   |   |
|---|---|---|
|  | Airbag  |  12V Batterie<br>12V Batterie<br>12V Batteria                            |
|  | Steuergerät<br>ECU<br>Centralina  |  Gasdruckdämpfer<br>Amortisseur à gaz<br>Ammortizzatore a gas            |
|  | Gasgenerator<br>Gazogène<br>Gassogeno                                   |  Überrollschutz<br>Arceau de sécurité<br>Protezione anticapottamento     |
|  | Karosserieverstärkung<br>Renfort de carrosserie<br>Rinforzo carrozzeria |  Gurtstraffer<br>Prétensionneur de ceinture<br>Pretensionatore di carico |
|  | Kraftstofftank<br>Réservoir de carburant<br>Serbatoio di carburante     |   |

Picanto



**Picanto (TA)**  
**ab/dès/dal 2011**  
**5- Tüer/Portes/Porte**











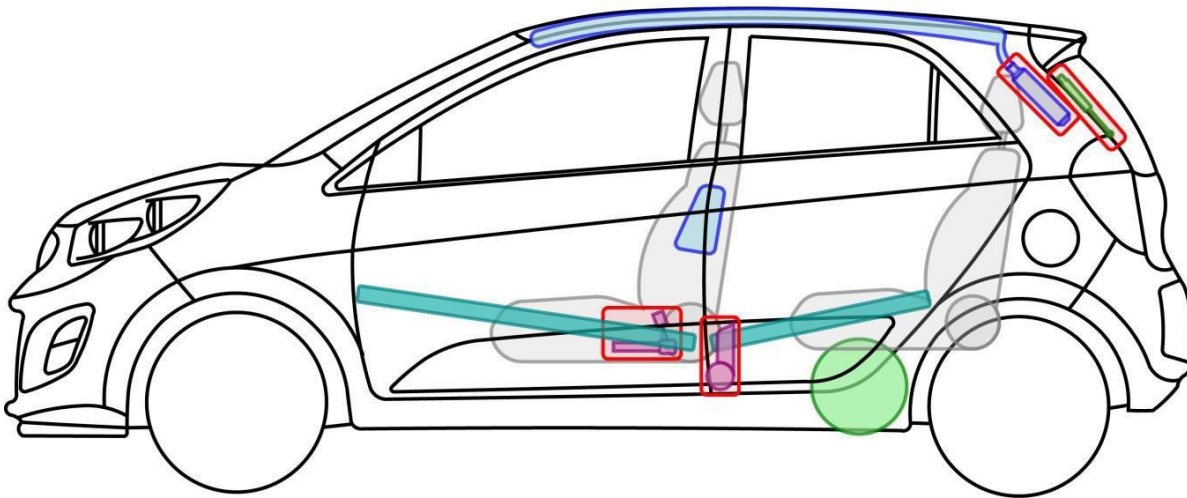
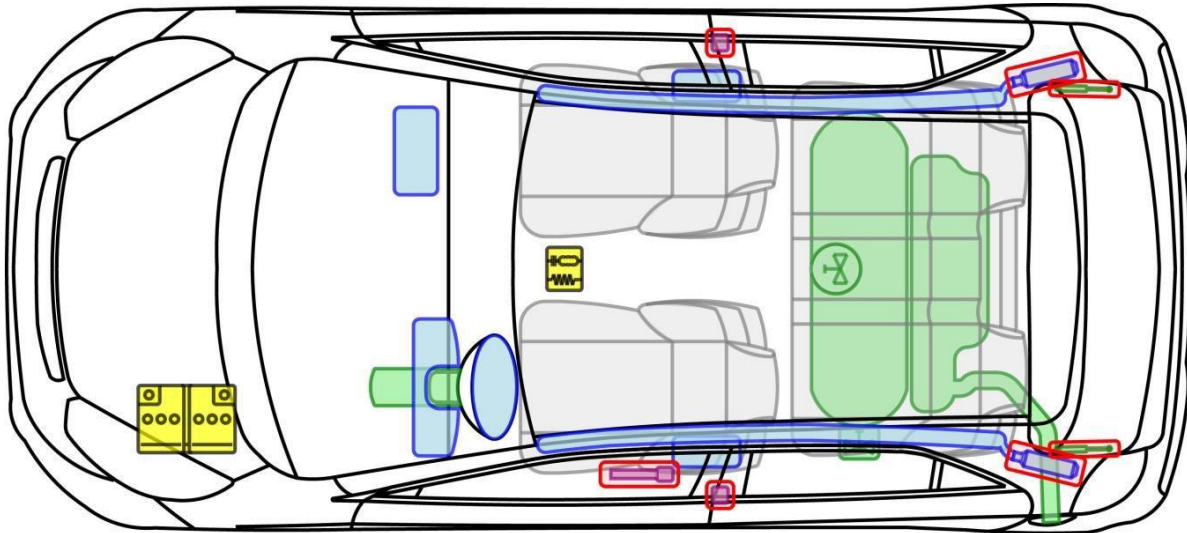

| Legende / Légende / Legenda   |   |   |
|---|---|---|
|  | Airbag  |  12V Batterie<br>12V Batterie<br>12V Batteria                            |
|  | Steuergerät<br>ECU<br>Centralina  |  Gasdruckdämpfer<br>Amortisseur à gaz<br>Ammortizzatore a gas            |
|  | Gasgenerator<br>Gazogène<br>Gassogeno                                   |  Überrollschutz<br>Arceau de sécurité<br>Protezione anticapottamento     |
|  | Karosserieverstärkung<br>Renfort de carrosserie<br>Rinforzo carrozzeria |  Gurtstraffer<br>Prétensionneur de ceinture<br>Pretensionatore di carico |
|  | Kraftstofftank<br>Réservoir de carburant<br>Serbatoio di carburante     |   |

Picanto



**Picanto (TA) LPG**  
**ab/dès/dal 2011**  
**5- Tüer/Portes/Porte**



| Legende / Légende / Legenda   |   |   |
|---|---|---|
|  | Airbag  |  12V Batterie<br>12V Batterie<br>12V Batteria                            |
|  | Steuergerät<br>ECU<br>Centralina  |  Gasdruckdämpfer<br>Amortisseur à gaz<br>Ammortizzatore a gas            |
|  | Gasgenerator<br>Gazogène<br>Gassogeno                                   |  Überrollschutz<br>Arceau de sécurité<br>Protezione anticapottamento     |
|  | Karosserieverstärkung<br>Renfort de carrosserie<br>Rinforzo carrozzeria |  Gurtstraffer<br>Prétensionneur de ceinture<br>Pretensionatore di carico |
|  | Kraftstofftank<br>Réservoir de carburant<br>Serbatoio di carburante     |   |







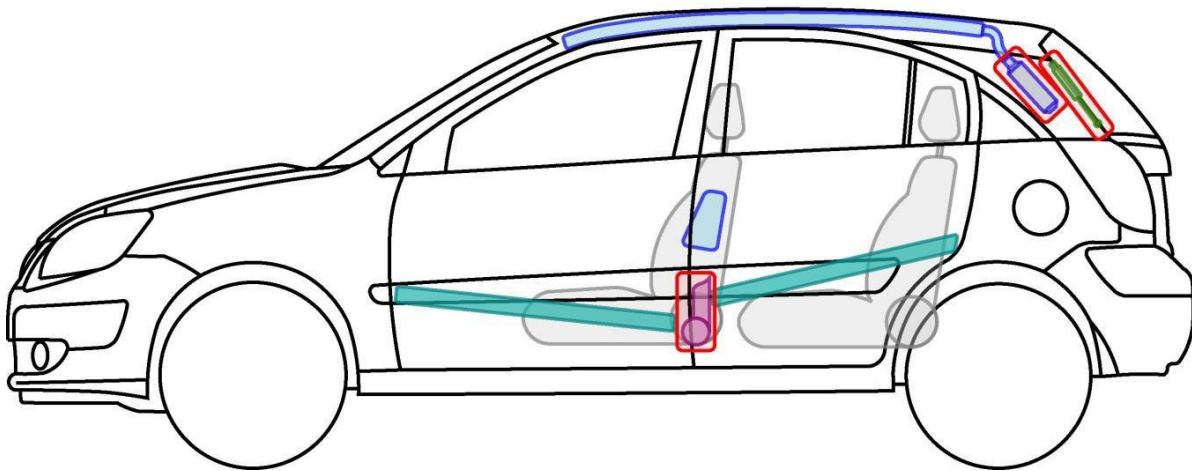
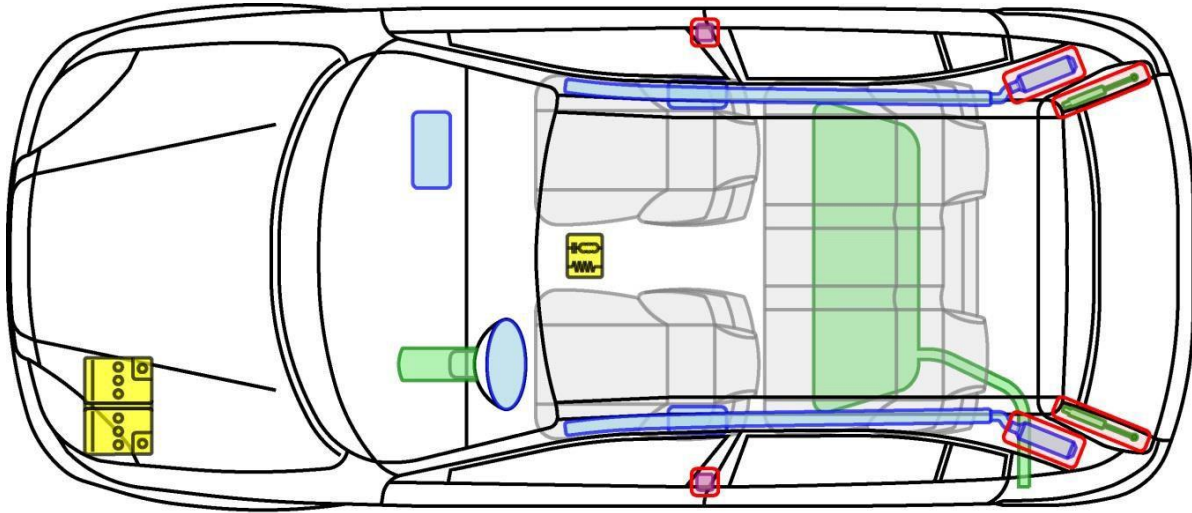

Picanto





# Rio (JB) 2005-2011











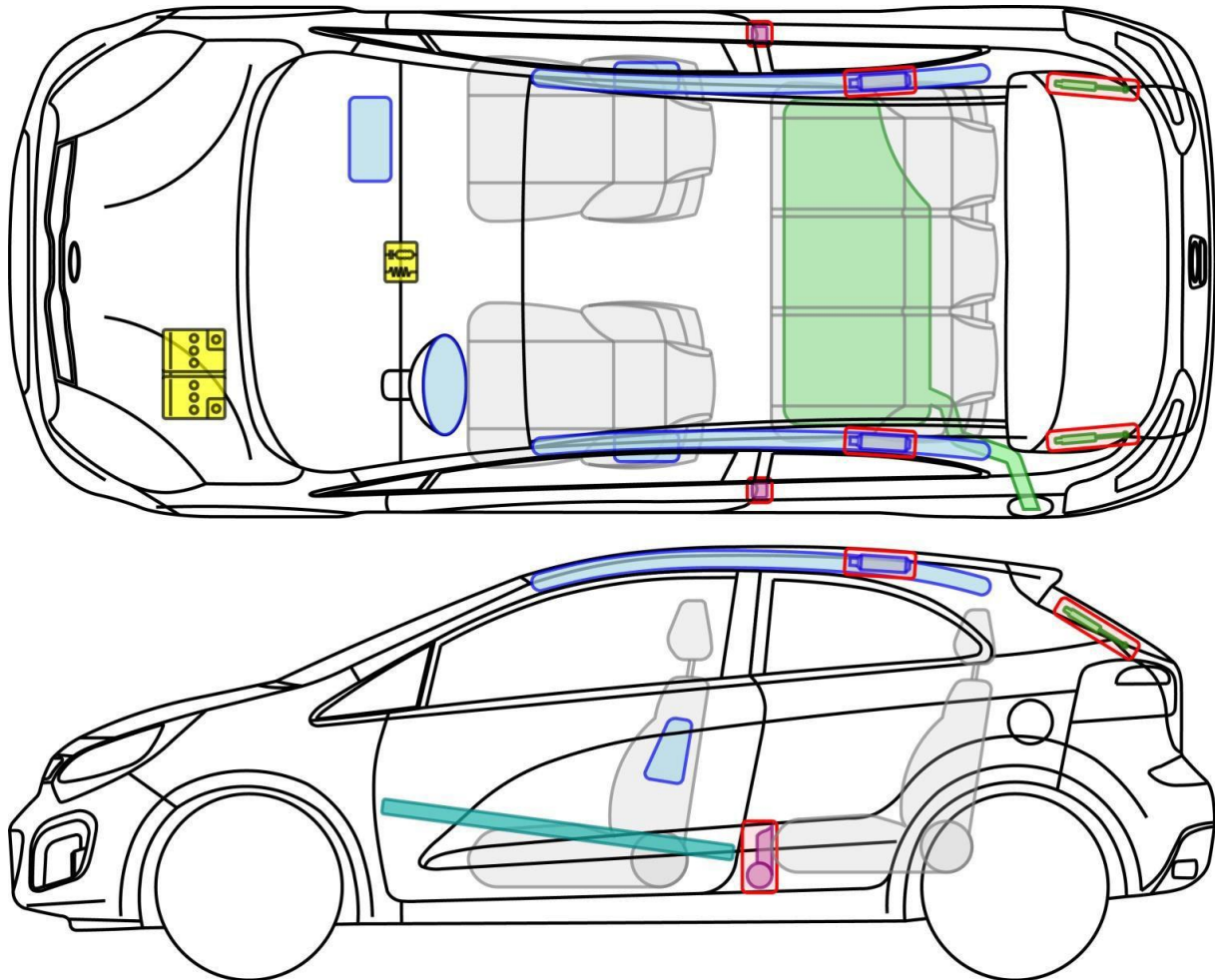

| Legende / Légende / Legenda   |   |  |
|---|---|--|
|  | Airbag  |  |
|  | Steuergerät<br>ECU<br>Centralina  |  |
|  | Gasgenerator<br>Gazogène<br>Gassogeno                                   |  |
|  | 12V Batterie<br>12V Batterie<br>12V Batteria                            |  |
|  | Karosserieverstärkung<br>Renfort de carrosserie<br>Rinforzo carrozzeria |  |
|  | Gurtstraffer<br>Prétensionneur de ceinture<br>Pretensionatore di carico |  |
|  | Gasdruckdämpfer<br>Amortisseur à gaz<br>Ammortizzatore a gas            |  |
|  | Überrollschutz<br>Arceau de sécurité<br>Protezione anticappottamento    |  |
|  | Kraftstofftank<br>Réservoir de carburant<br>Serbatoio di carburante     |  |

Rio



**Rio (JB)**  
**ab/dès/dal 2011**  
**3- Tüerer/Portes/Porte**



| Legende / Légende / Legenda   |   |  |
|---|---|--|
|  | Airbag  |  |
|  | Steuergerät<br>ECU<br>Centralina  |  |
|  | Gasgenerator<br>Gazogène<br>Gassogeno                                   |  |
|  | 12V Batterie<br>12V Batterie<br>12V Batteria                            |  |
|  | Karosserieverstärkung<br>Renfort de carrosserie<br>Rinforzo carrozzeria |  |
|  | Gurtstraffer<br>Prétensionneur de ceinture<br>Pretensionatore di carico |  |
|  | Gasdruckdämpfer<br>Amortisseur à gaz<br>Ammortizzatore a gas            |  |
|  | Überrollschutz<br>Arceau de sécurité<br>Protezione anticapottamento     |  |
|  | Kraftstofftank<br>Réservoir de carburant<br>Serbatoio di carburante     |  |

Rio



**Rio (UB)**  
**ab/dès/dal 2011**  
**5- Tüer/Portes/Porte**

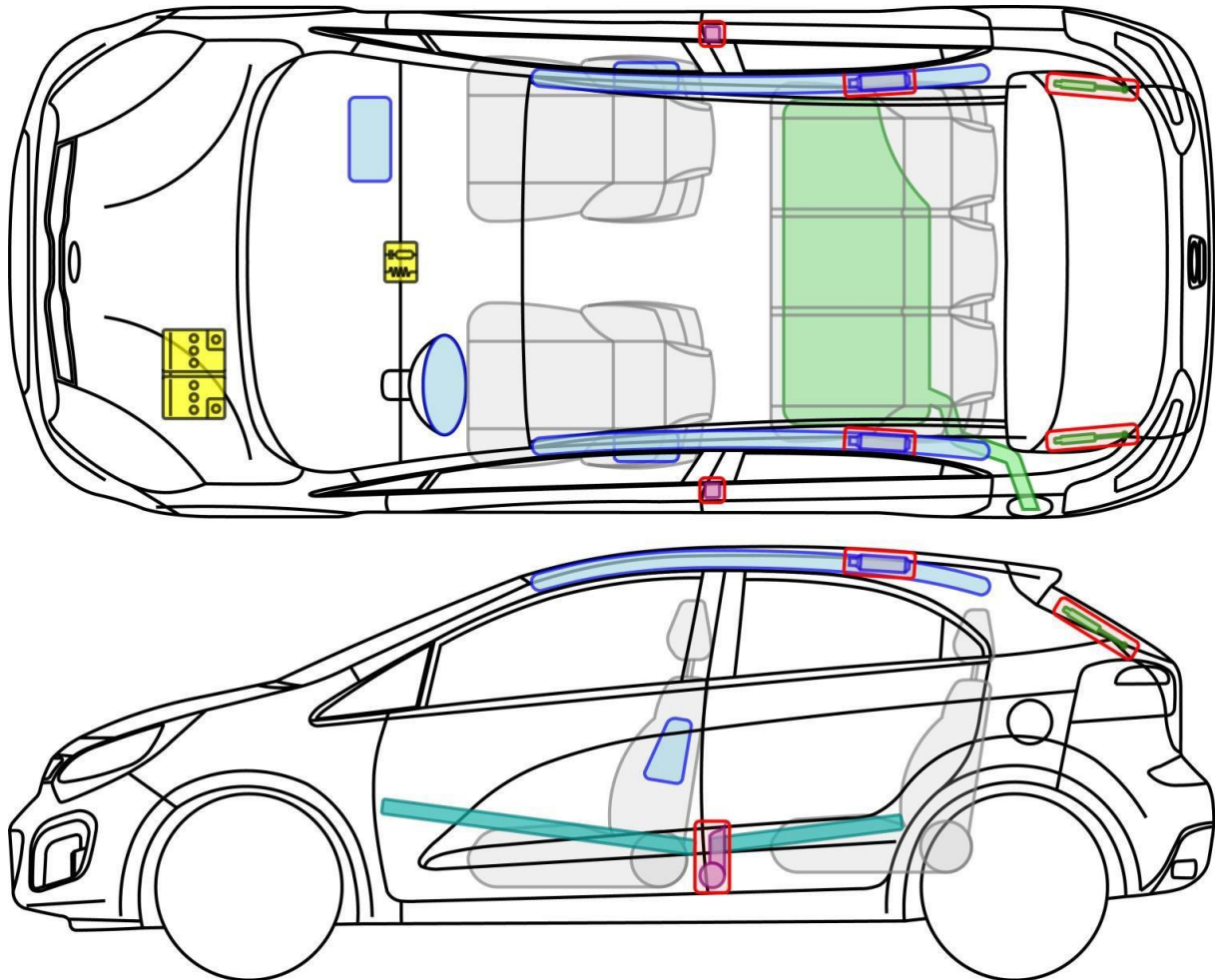

**Legende / Légende / Legenda**

|  |                                       |  |   |  |   |
|--|---------------------------------------|--|---|--|---|
|  | Airbag                                |  | 12V Batterie<br>12V Batterie<br>12V Batteria                            |  | Gasdruckdämpfer<br>Amortisseur à gaz<br>Ammortizzatore a gas        |
|  | Steuergerät<br>ECU<br>Centralina      |  | Karosserieverstärkung<br>Renfort de carrosserie<br>Rinforzo carrozzeria |  | Überrollschutz<br>Arceau de sécurité<br>Protezione anticapottamento |
|  | Gasgenerator<br>Gazogène<br>Gassogeno |  | Gurtstraffer<br>Prétensionneur de ceinture<br>Pretensionatore di carico |  | Kraftstofftank<br>Réservoir de carburant<br>Serbatoio di carburante |

Rio



**Soul (AM)**  
ab/dès/dal 2009

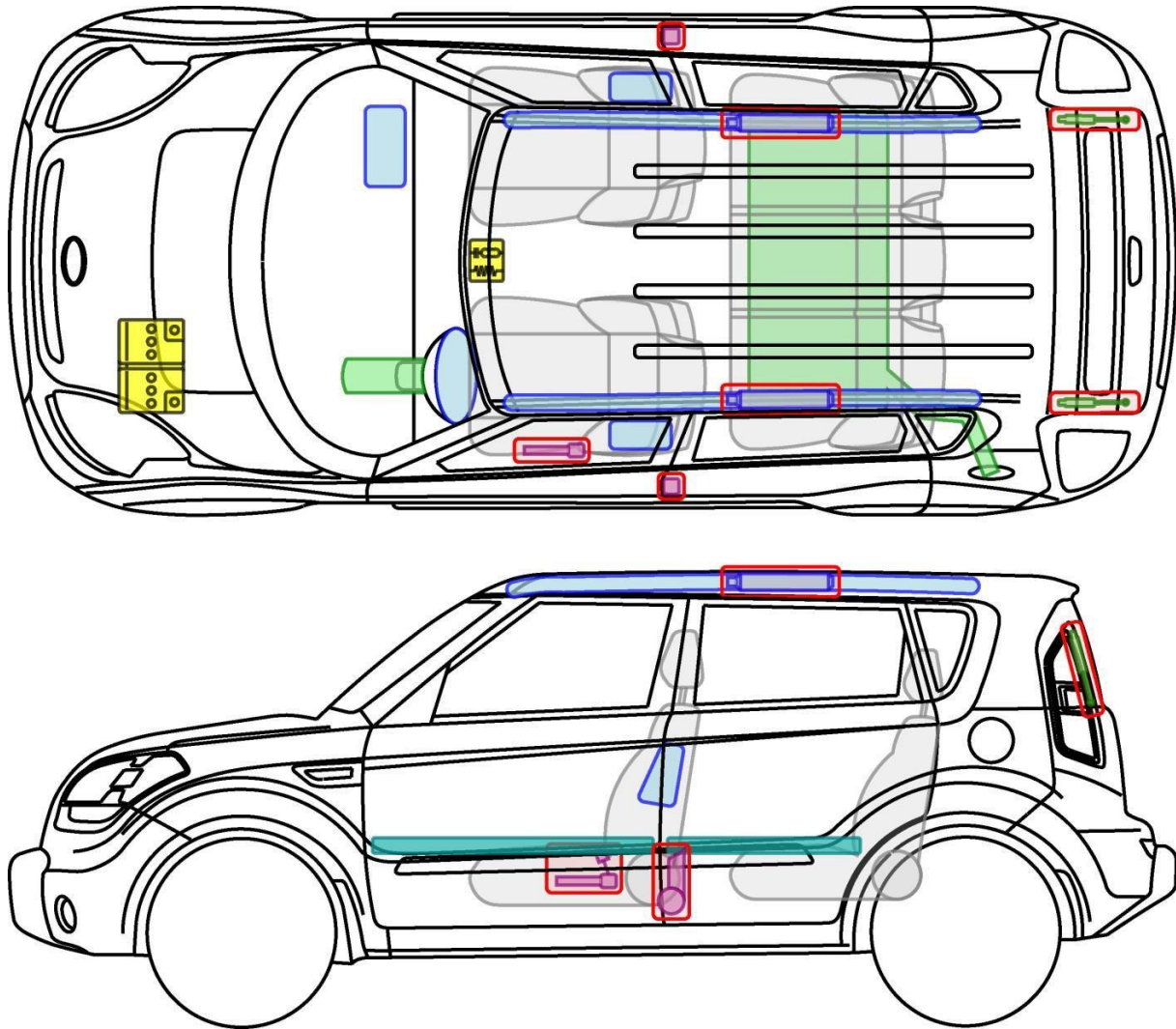

Legende / Légende / Legenda

|   |                                       |   |   |   |   |
|---|---------------------------------------|---|---|---|---|
|  | Airbag                                |  | 12V Batterie<br>12V Batterie<br>12V Batteria                            |  | Gasdruckdämpfer<br>Amortisseur à gaz<br>Ammortizzatore a gas        |
|  | Steuergerät<br>ECU<br>Centralina      |  | Karosserieverstärkung<br>Renfort de carrosserie<br>Rinforzo carrozzeria |  | Überrollschutz<br>Arceau de sécurité<br>Protezione anticapottamento |
|  | Gasgenerator<br>Gazogène<br>Gassogeno |  | Gurtstraffer<br>Prétensionneur de ceinture<br>Pretensionatore di carico |  | Kraftstofftank<br>Réservoir de carburant<br>Serbatoio di carburante |







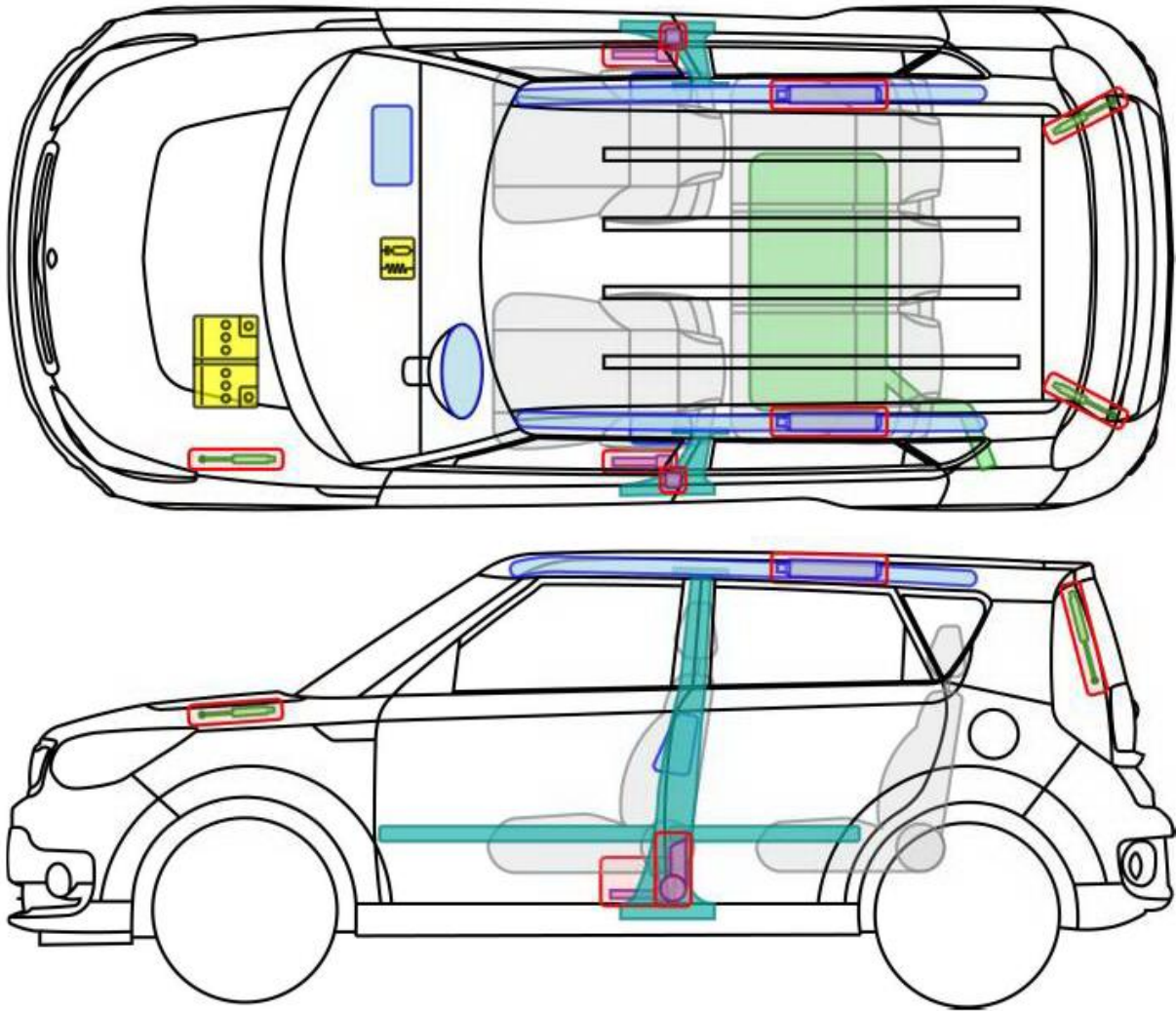

Soul



**Soul (PS)**  
**ab/dès/dal 2014**



**Legende / Légende / Legenda**

|   |                                       |   |   |   |   |
|---|---------------------------------------|---|---|---|---|
|  | Airbag                                |  | 12V Batterie<br>12V Batterie<br>12V Batteria                            |  | Gasdruckdämpfer<br>Amortisseur à gaz<br>Ammortizzatore a gas        |
|  | Steuergerät<br>ECU<br>Centralina      |  | Karosserieverstärkung<br>Renfort de carrosserie<br>Rinforzo carrozzeria |  | Überrollschutz<br>Arceau de sécurité<br>Protezione anticapottamento |
|  | Gasgenerator<br>Gazogène<br>Gassogeno |  | Gurtstraffer<br>Prétensionneur de ceinture<br>Pretensionatore di carico |  | Kraftstofftank<br>Réservoir de carburant<br>Serbatoio di carburante |







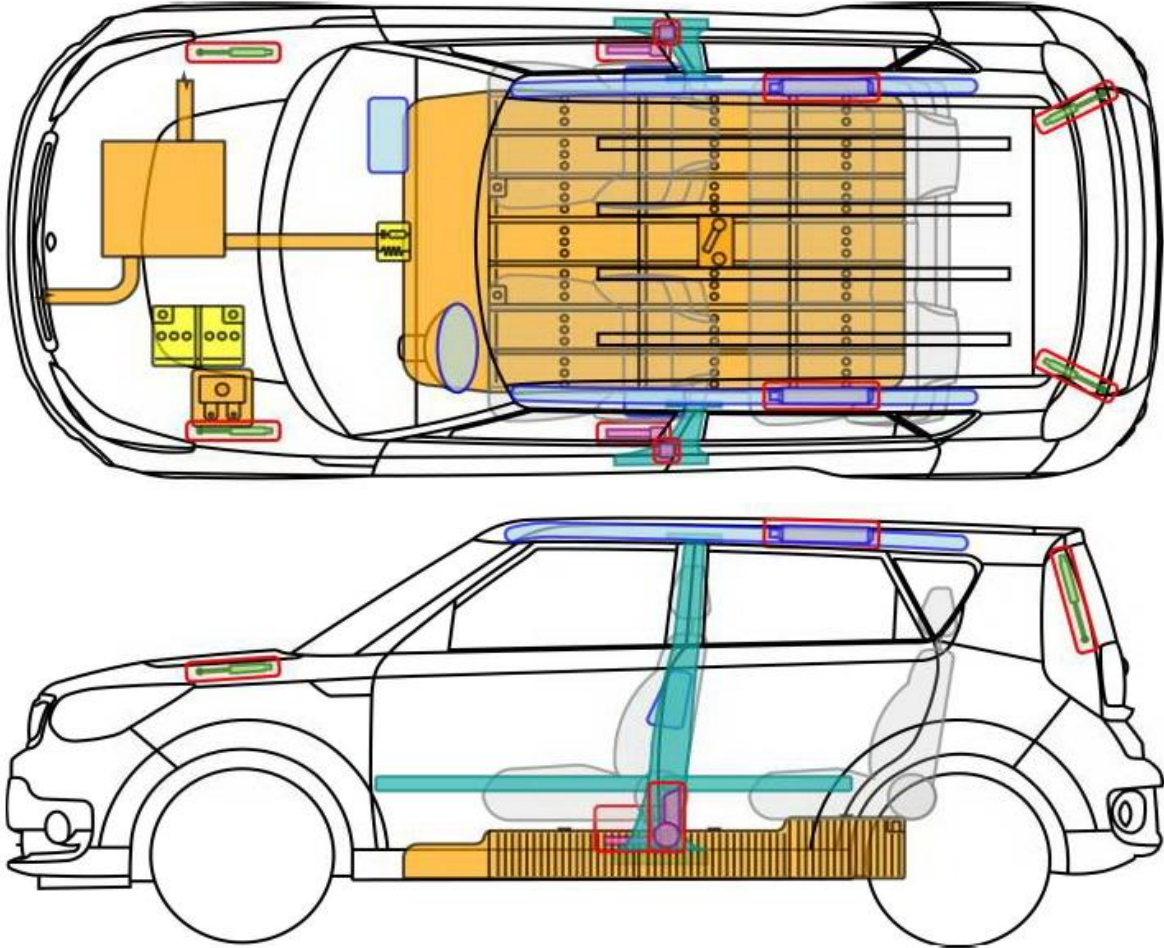



Soul



# Soul EV (PS EV) ab/dès/dal 2014



## Legende / Légende / Legenda

|   |   |   |   |   |   |
|---|---|---|---|---|---|
|  | Airbag  |  | 12V Batterie<br>12V Batterie<br>12V Batteria                                    |  | Gasdruckdämpfer<br>Amortisseur à gaz<br>Ammortizzatore a gas  |
|  | Steuergerät<br>ECU<br>Centralina  |  | Karosserieverstärkung<br>Renfort de carrosserie<br>Rinforzo carrozzeria         |  | Überrollschutz<br>Arceau de sécurité<br>Protezione anticappottamento  |
|  | Gasgenerator<br>Gazogène<br>Gassogeno                                   |  | Gurtstraffer<br>Prétensionneur de ceinture<br>Pretensionatore di carico         |  | Kraftstofftank<br>Réservoir de carburant<br>Serbatoio di carburante   |
|  | Hochvoltbatterie<br>Batterie haute tension<br>Batteria ad alta tensione |  | Hochvoltkomponenten<br>Composants haute tension<br>Componenti ad alto voltaggio |  | Hochvolt Trennstelle<br>Dispositif de coupure haute tension<br>Dispositivo di disinserimento alto voltaggio |







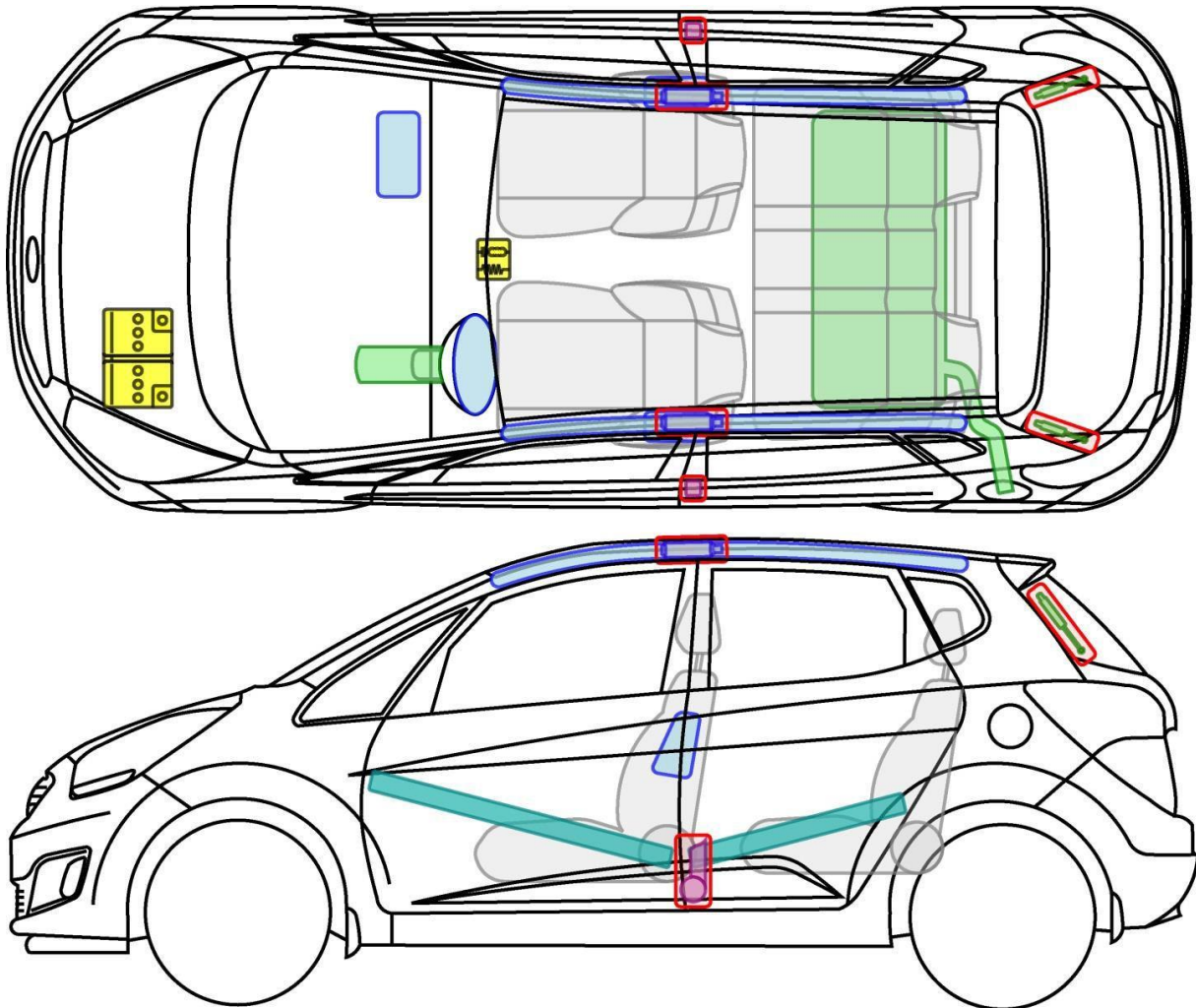

Soul EV



**Venga (YN)**  
**ab/dès/dal 2010**



**Legende / Légende / Legenda**







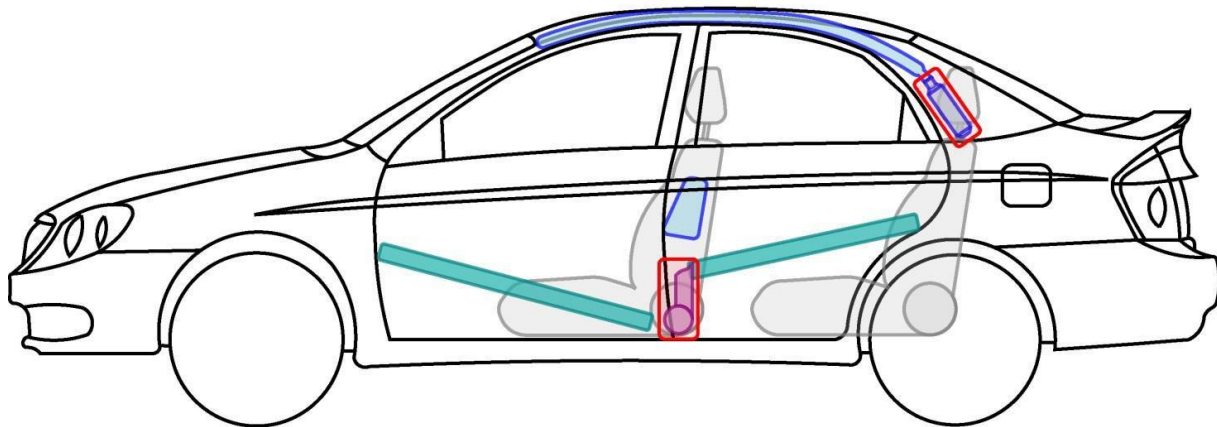
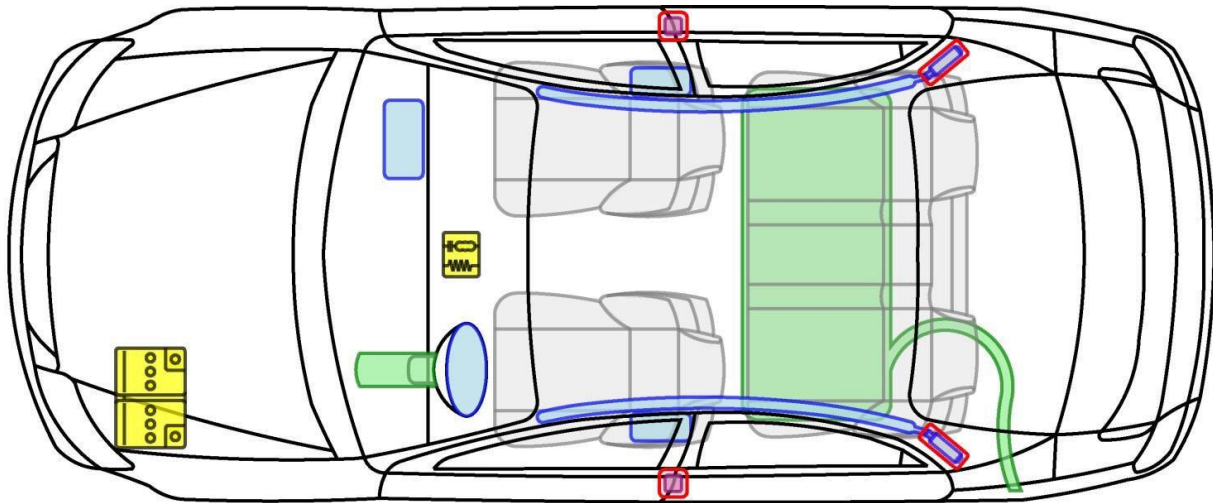

|   |                                       |   |   |   |  |
|---|---------------------------------------|---|---|---|--|
|  | Airbag                                |  | 12V Batterie<br>12V Batterie<br>12V Batteria                            |  | Gasdruckdämpfer<br>Amortisseur à gaz<br>Ammortizzatore a gas         |
|  | Steuergerät<br>ECU<br>Centralina      |  | Karosserieverstärkung<br>Renfort de carrosserie<br>Rinforzo carrozzeria |  | Überrollschutz<br>Arceau de sécurité<br>Protezione anticappottamento |
|  | Gasgenerator<br>Gazogène<br>Gassogeno |  | Gurtstraffer<br>Prétensionneur de ceinture<br>Pretensionatore di carico |  | Kraftstofftank<br>Réservoir de carburant<br>Serbatoio di carburante  |

Venga



# Cerato (LD) 2004-2009



| Legende / Légende / Legenda   |                                       |   |
|---|---------------------------------------|---|
|  | Airbag                                |  12V Batterie<br>12V Batterie<br>12V Batteria                            |
|  | Steuergerät<br>ECU<br>Centralina      |  Karosserieverstärkung<br>Renfort de carrosserie<br>Rinforzo carrozzeria |
|  | Gasgenerator<br>Gazogène<br>Gassogeno |  Gurtstraffer<br>Prétensionneur de ceinture<br>Pretensionatore di carico |
|   |                                       |  Gasdruckdämpfer<br>Amortisseur à gaz<br>Ammortizzatore a gas            |
|   |                                       |  Überrollschutz<br>Arceau de sécurité<br>Protezione anticapottamento     |
|   |                                       |  Kraftstofftank<br>Réservoir de carburant<br>Serbatoio di carburante     |

Cerato







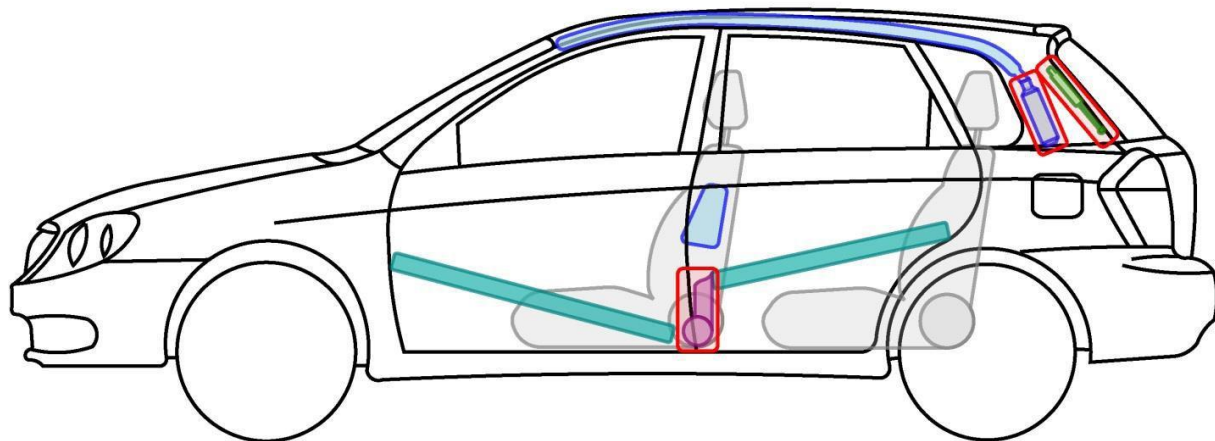
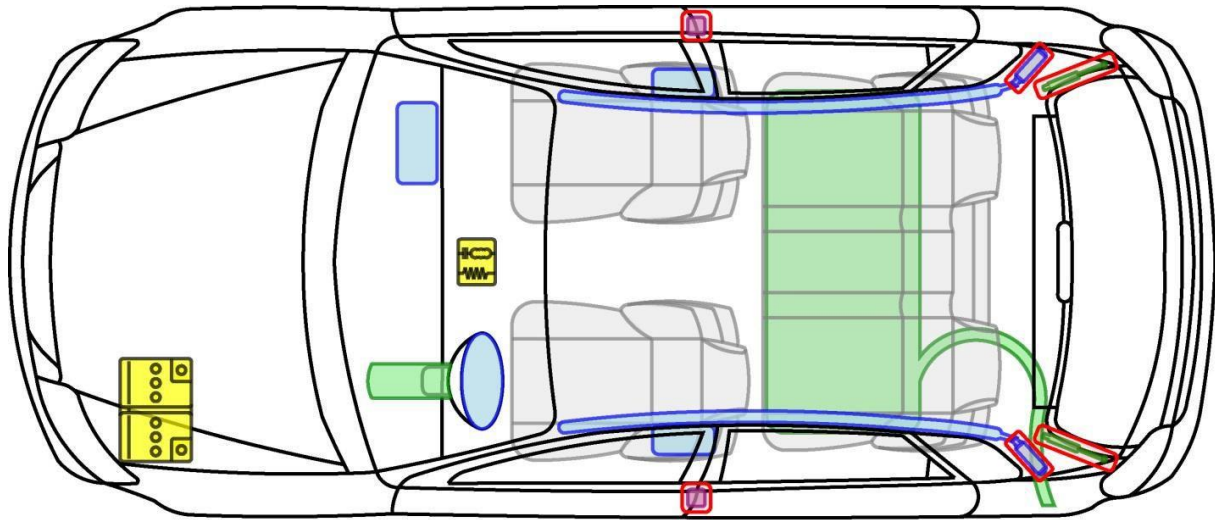





**Cerato (LD)**  
**2004-2011**  
**5- Tüer/Portes/Porte**



**Legende / Légende / Legenda**

|   |                                       |   |   |   |  |
|---|---------------------------------------|---|---|---|--|
|  | Airbag                                |  | 12V Batterie<br>12V Batterie<br>12V Batteria                            |  | Gasdruckdämpfer<br>Amortisseur à gaz<br>Ammortizzatore a gas         |
|  | Steuergerät<br>ECU<br>Centralina      |  | Karosserieverstärkung<br>Renfort de carrosserie<br>Rinforzo carrozzeria |  | Überrollschutz<br>Arceau de sécurité<br>Protezione anticappottamento |
|  | Gasgenerator<br>Gazogène<br>Gassogeno |  | Gurtstraffer<br>Prétensionneur de ceinture<br>Pretensionatore di carico |  | Kraftstofftank<br>Réservoir de carburant<br>Serbatoio di carburante  |

Cerato



**cee'd (ED)**  
**2007-2012**  
**5- Tüer/Portes/Porte**

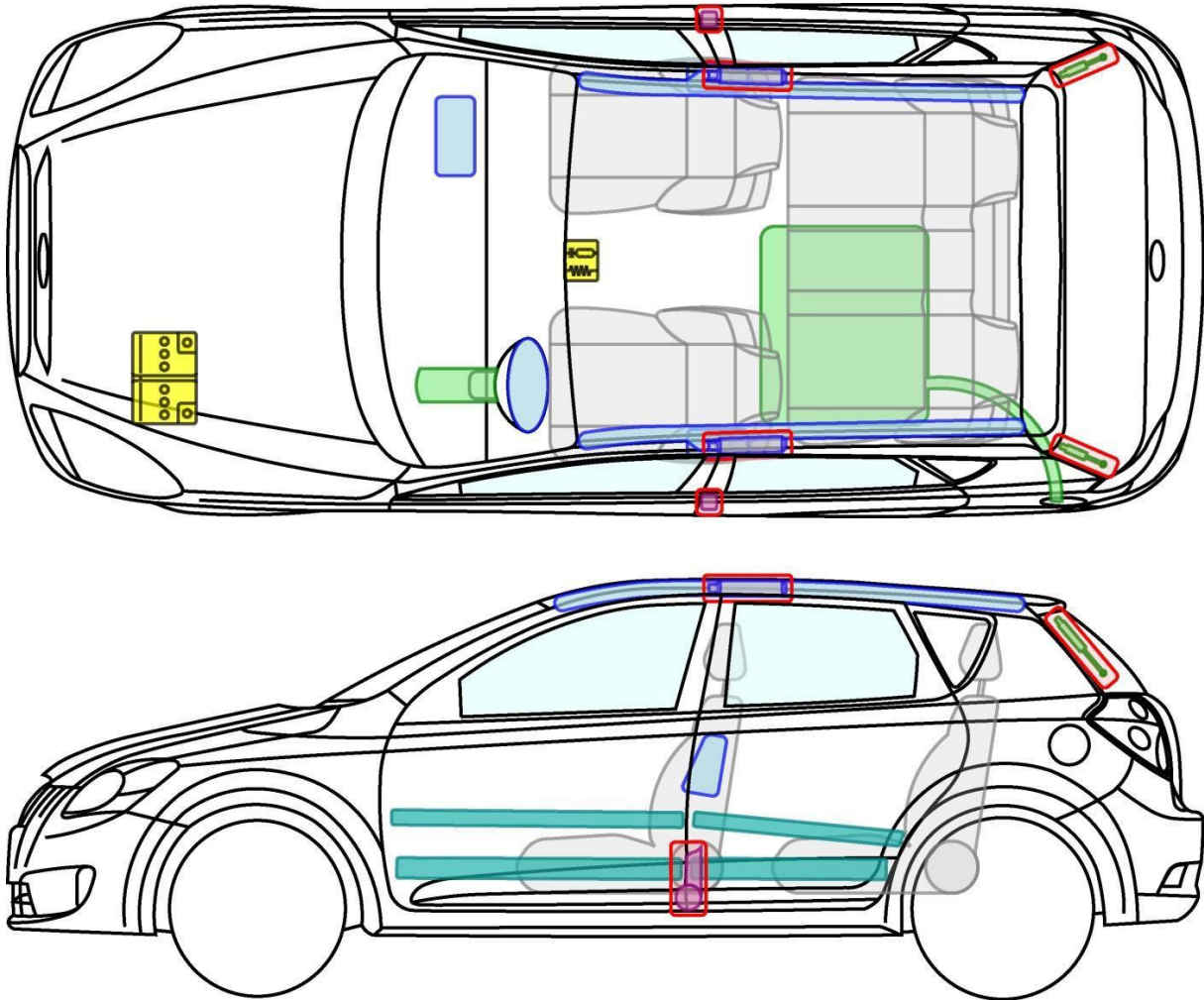

**Legende / Légende / Legenda**



Airbag



12V Batterie  
12V Batterie  
12V Batteria



Gasdruckdämpfer  
Amortisseur à gaz  
Ammortizzatore a gas



Steuergerät  
ECU  
Centralina



Karosserieverstärkung  
Renfort de carrosserie  
Rinforzo carrozzeria



Überrollschutz  
Arceau de sécurité  
Protezione anticappottamento



Gasgenerator  
Gazogène  
Gassogeno



Gurtstraffer  
Prétensionneur de ceinture  
Pretensionatore di carico



Kraftstofftank  
Réservoir de carburant  
Serbatoio di carburante





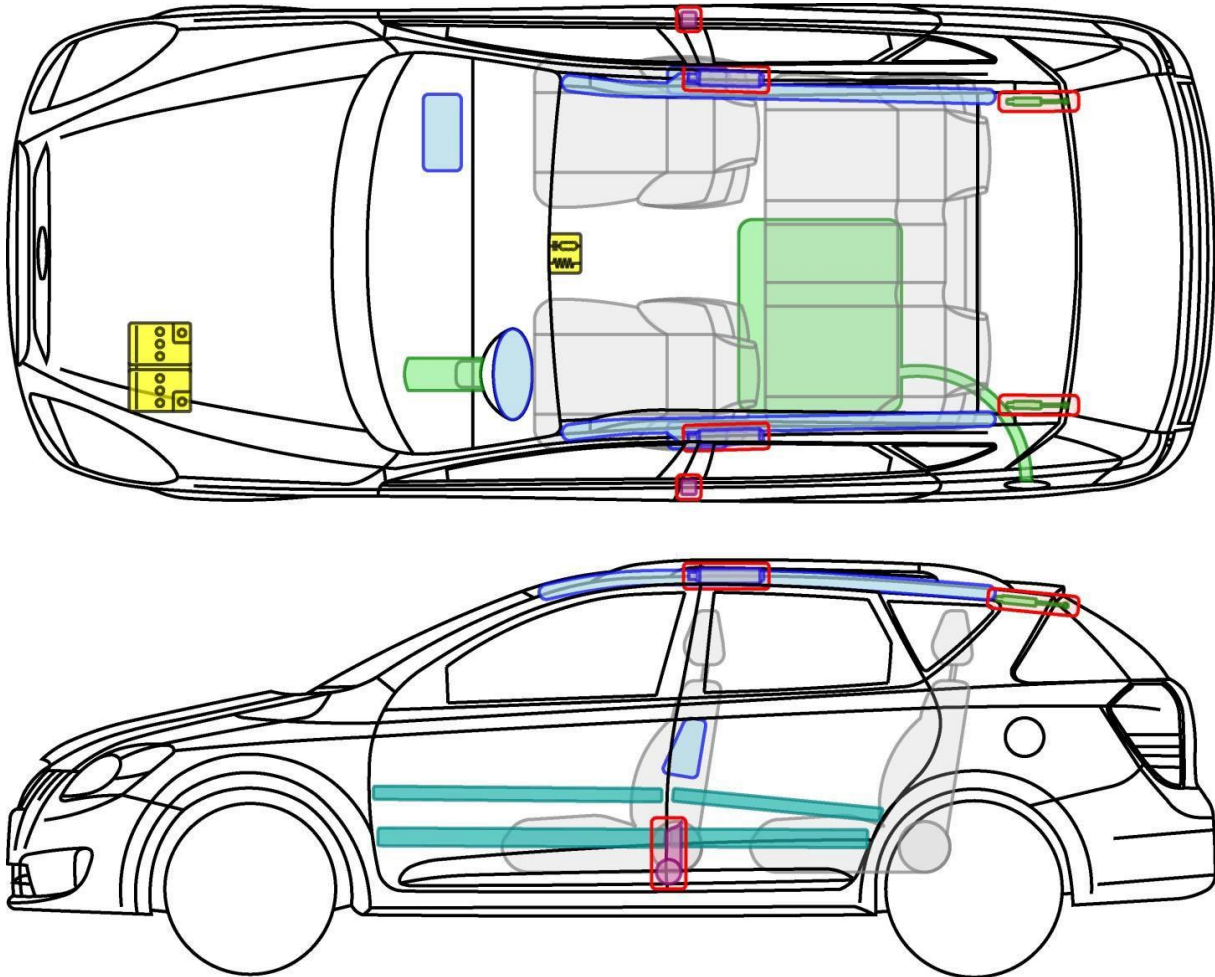

cee'd



**cee'd sw (ED)**  
**2007-2012**  
**Sportswagon**



**Legende / Légende / Legenda**

|   |                                       |   |   |   |   |
|---|---------------------------------------|---|---|---|---|
|  | Airbag                                |  | 12V Batterie<br>12V Batterie<br>12V Batteria                            |  | Gasdruckdämpfer<br>Amortisseur à gaz<br>Ammortizzatore a gas        |
|  | Steuergerät<br>ECU<br>Centralina      |  | Karosserieverstärkung<br>Renfort de carrosserie<br>Rinforzo carrozzeria |  | Überrollschutz<br>Arceau de sécurité<br>Protezione anticapottamento |
|  | Gasgenerator<br>Gazogène<br>Gassogeno |  | Gurtstraffer<br>Prétensionneur de ceinture<br>Pretensionatore di carico |  | Kraftstofftank<br>Réservoir de carburant<br>Serbatoio di carburante |

cee'd



**cee'd (ED)  
2007-2012  
5- Tüer/Portes/Porte**

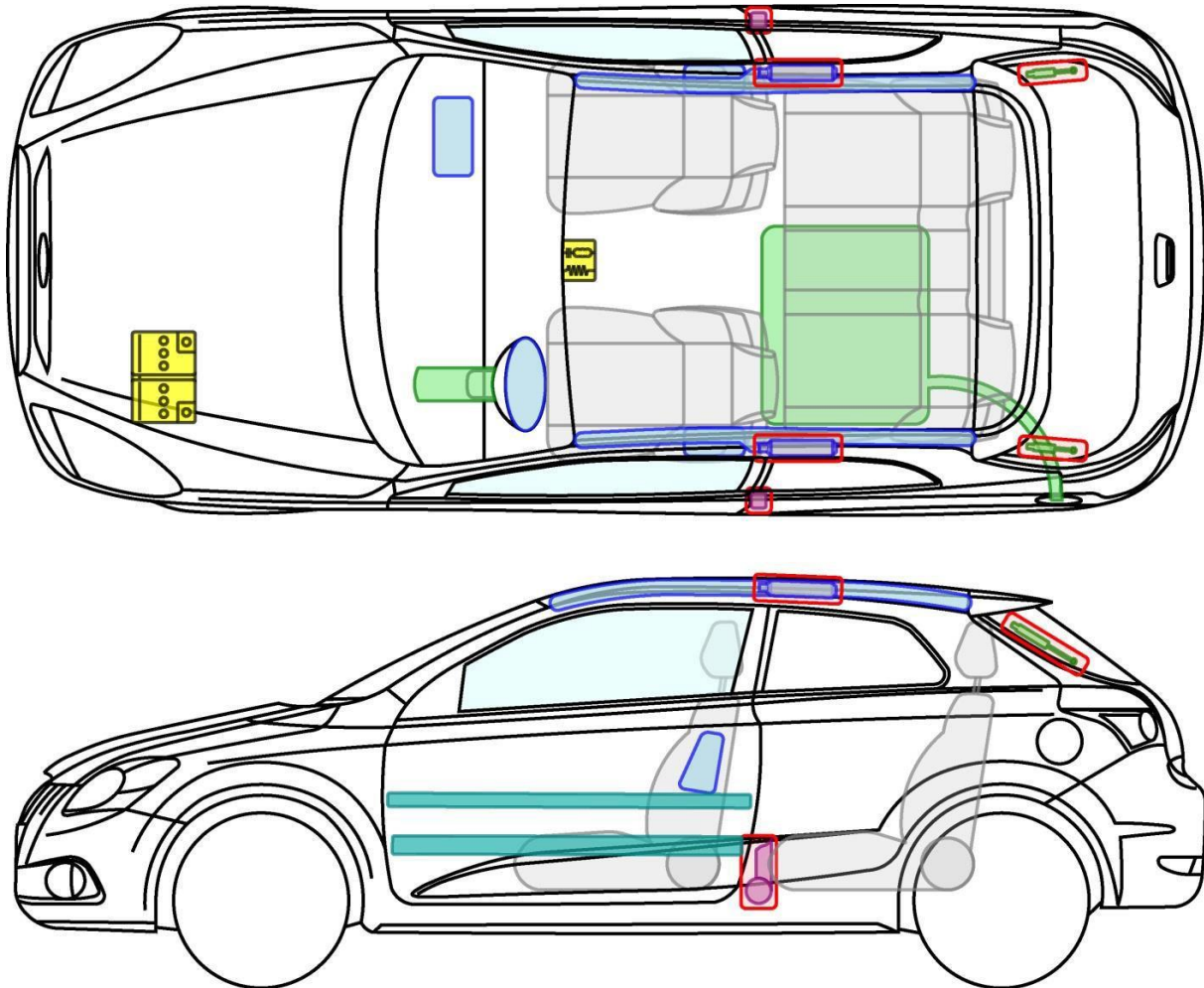

**Legende / Légende / Legenda**



Airbag



12V Batterie  
12V Batterie  
12V Batteria



Gasdruckdämpfer  
Amortisseur à gaz  
Ammortizzatore a gas



Steuergerät  
ECU  
Centralina



Karosserieverstärkung  
Renfort de carrosserie  
Rinforzo carrozzeria



Überrollschutz  
Arceau de sécurité  
Protezione anticappottamento



Gasgenerator  
Gazogène  
Gassogeno



Gurtstraffer  
Prétensionneur de ceinture  
Pretensionatore di carico



Kraftstofftank  
Réservoir de carburant  
Serbatoio di carburante







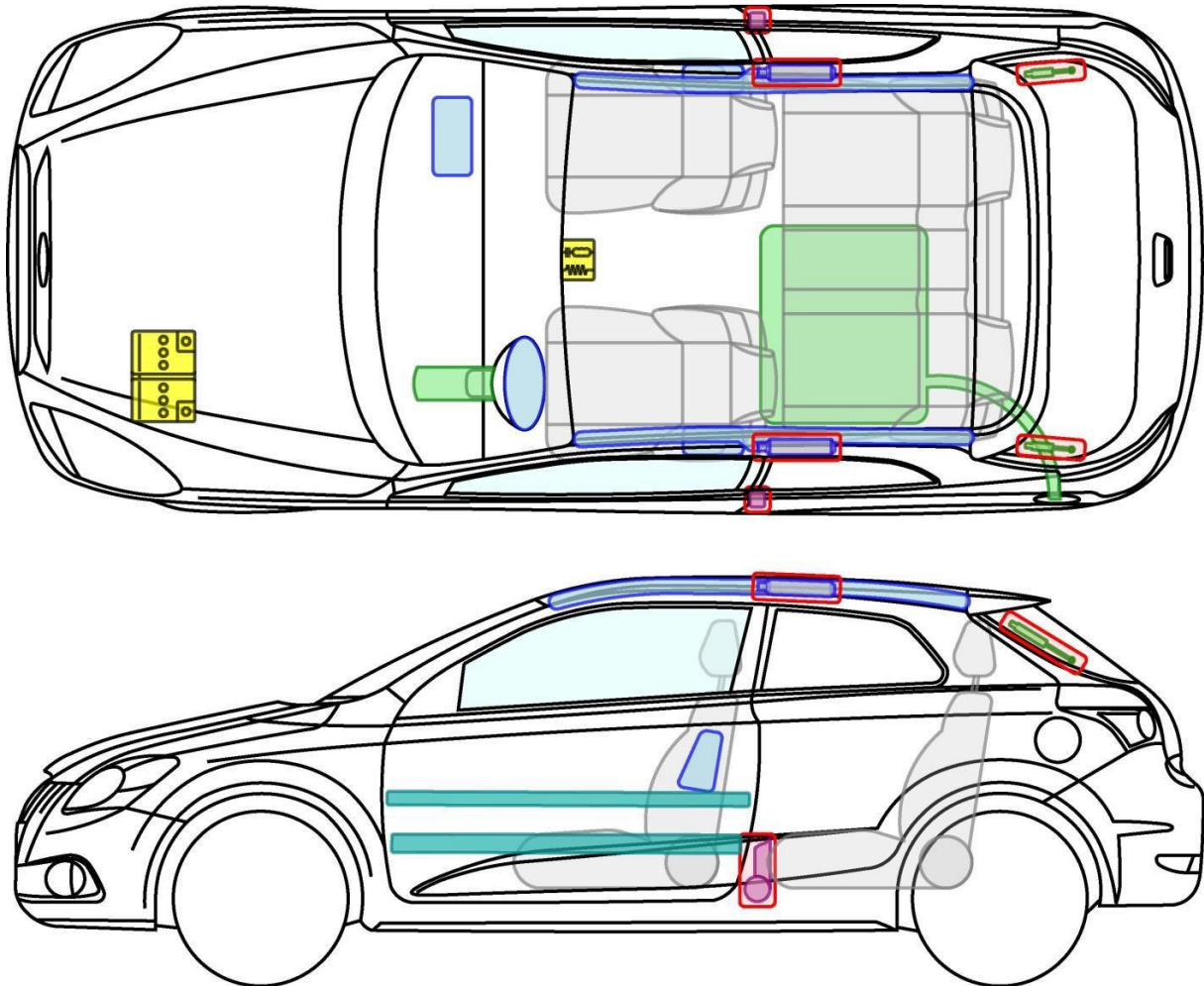





**pro cee'd (ED)**  
**2008-2012**  
**3- Tüer/Portes/Porte**



**Legende / Légende / Legenda**

|   |                                       |   |   |   |  |
|---|---------------------------------------|---|---|---|--|
|  | Airbag                                |  | 12V Batterie<br>12V Batterie<br>12V Batteria                            |  | Gasdruckdämpfer<br>Amortisseur à gaz<br>Ammortizzatore a gas         |
|  | Steuergerät<br>ECU<br>Centralina      |  | Karosserieverstärkung<br>Renfort de carrosserie<br>Rinforzo carrozzeria |  | Überrollschutz<br>Arceau de sécurité<br>Protezione anticappottamento |
|  | Gasgenerator<br>Gazogène<br>Gassogeno |  | Gurtstraffer<br>Prétensionneur de ceinture<br>Pretensionatore di carico |  | Kraftstofftank<br>Réservoir de carburant<br>Serbatoio di carburante  |

cee'd



**cee'd (JD)**  
**ab/dès/dal 2012**  
**5- Tüerer/Portes/Porte**

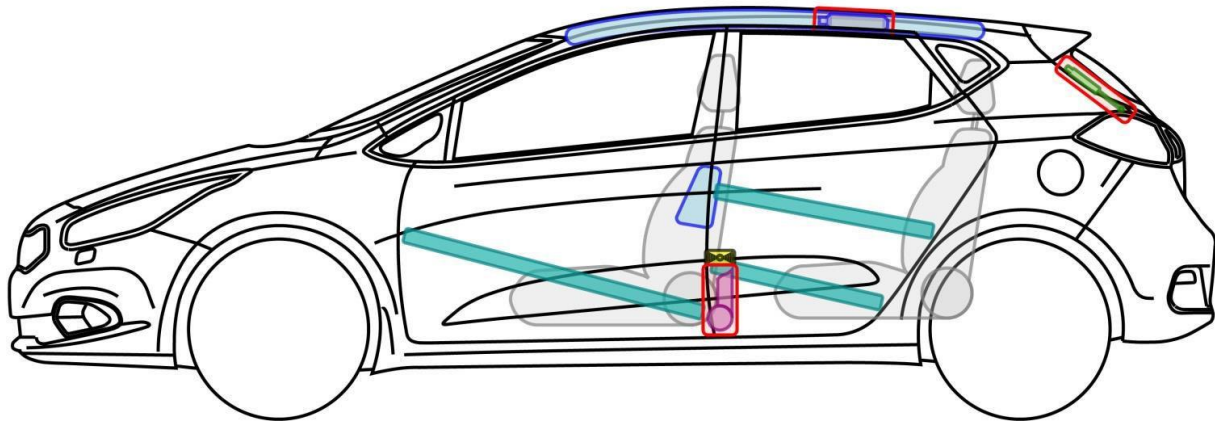
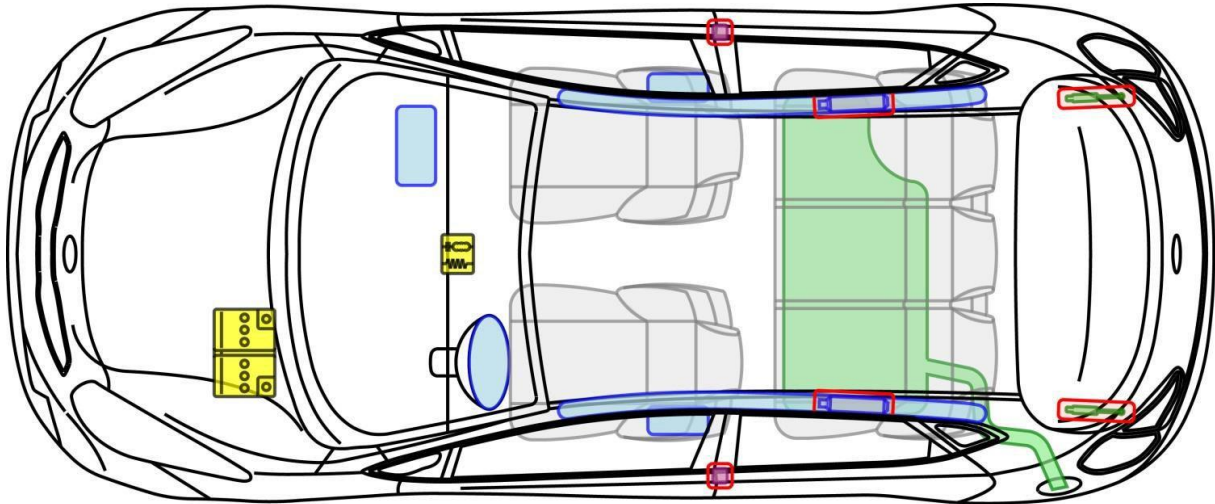

**Legende / Légende / Legenda**







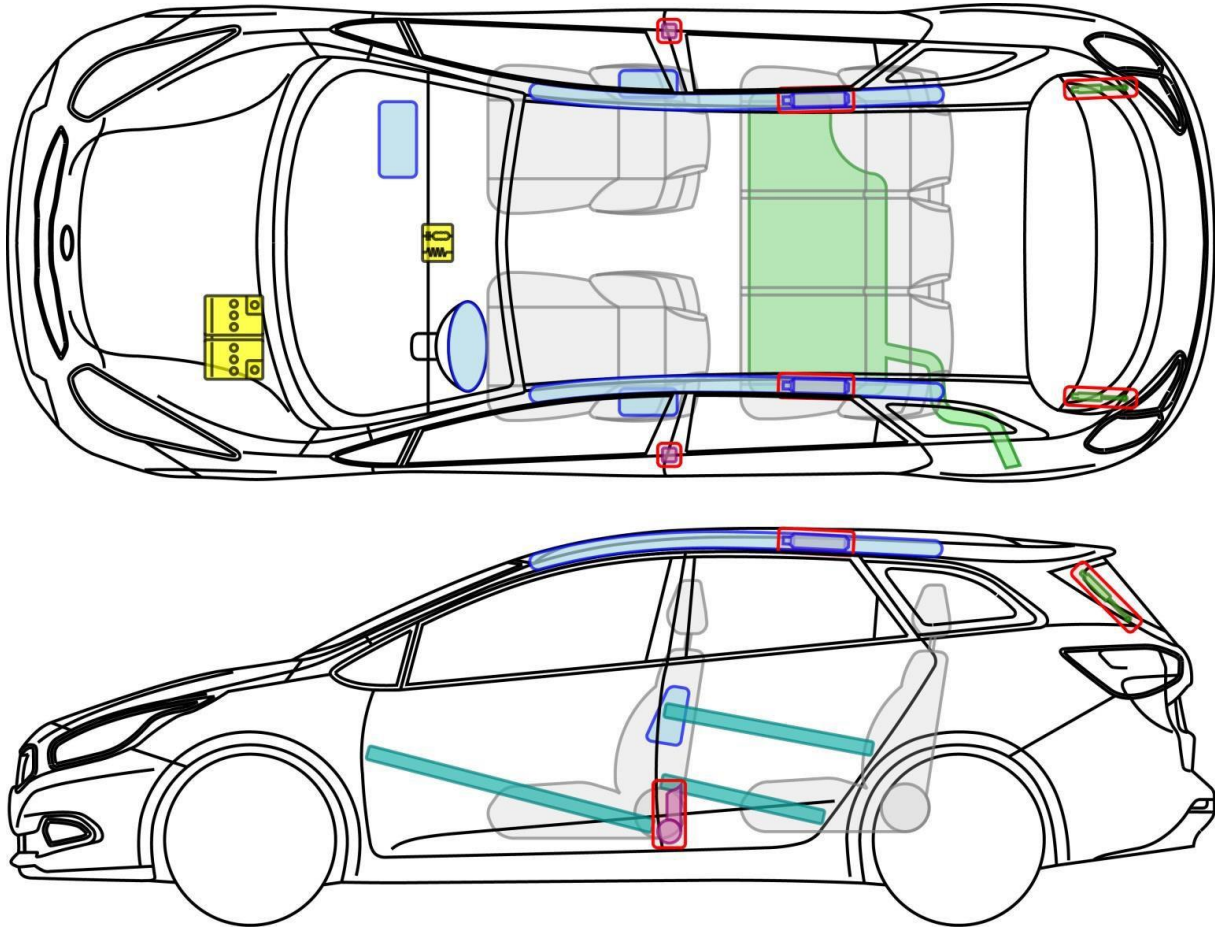

|   |                                       |   |   |   |  |
|---|---------------------------------------|---|---|---|--|
|  | Airbag                                |  | 12V Batterie<br>12V Batterie<br>12V Batteria                            |  | Gasdruckdämpfer<br>Amortisseur à gaz<br>Ammortizzatore a gas         |
|  | Steuergerät<br>ECU<br>Centralina      |  | Karosserieverstärkung<br>Renfort de carrosserie<br>Rinforzo carrozzeria |  | Überrollschutz<br>Arceau de sécurité<br>Protezione anticappottamento |
|  | Gasgenerator<br>Gazogène<br>Gassogeno |  | Gurtstraffer<br>Prétensionneur de ceinture<br>Pretensionatore di carico |  | Kraftstofftank<br>Réservoir de carburant<br>Serbatoio di carburante  |





**cee'd sw (JD)**  
**ab/dès/dal 2012**  
**Sportswagon**



| Legende / Légende / Legenda   |                                       |   |
|---|---------------------------------------|---|
|  | Airbag                                |  12V Batterie<br>12V Batterie<br>12V Batteria                            |
|  | Steuergerät<br>ECU<br>Centralina      |  Karosserieverstärkung<br>Renfort de carrosserie<br>Rinforzo carrozzeria |
|  | Gasgenerator<br>Gazogène<br>Gassogeno |  Gurtstraffer<br>Prétensionneur de ceinture<br>Pretensionatore di carico |
|   |                                       |  Gasdruckdämpfer<br>Amortisseur à gaz<br>Ammortizzatore a gas            |
|   |                                       |  Überrollschutz<br>Arceau de sécurité<br>Protezione anticapottamento     |
|   |                                       |  Kraftstofftank<br>Réservoir de carburant<br>Serbatoio di carburante     |





**pro cee'd (JD)**  
**ab/dès/dal 2013**  
**3- Tüer/Portes/Porte**

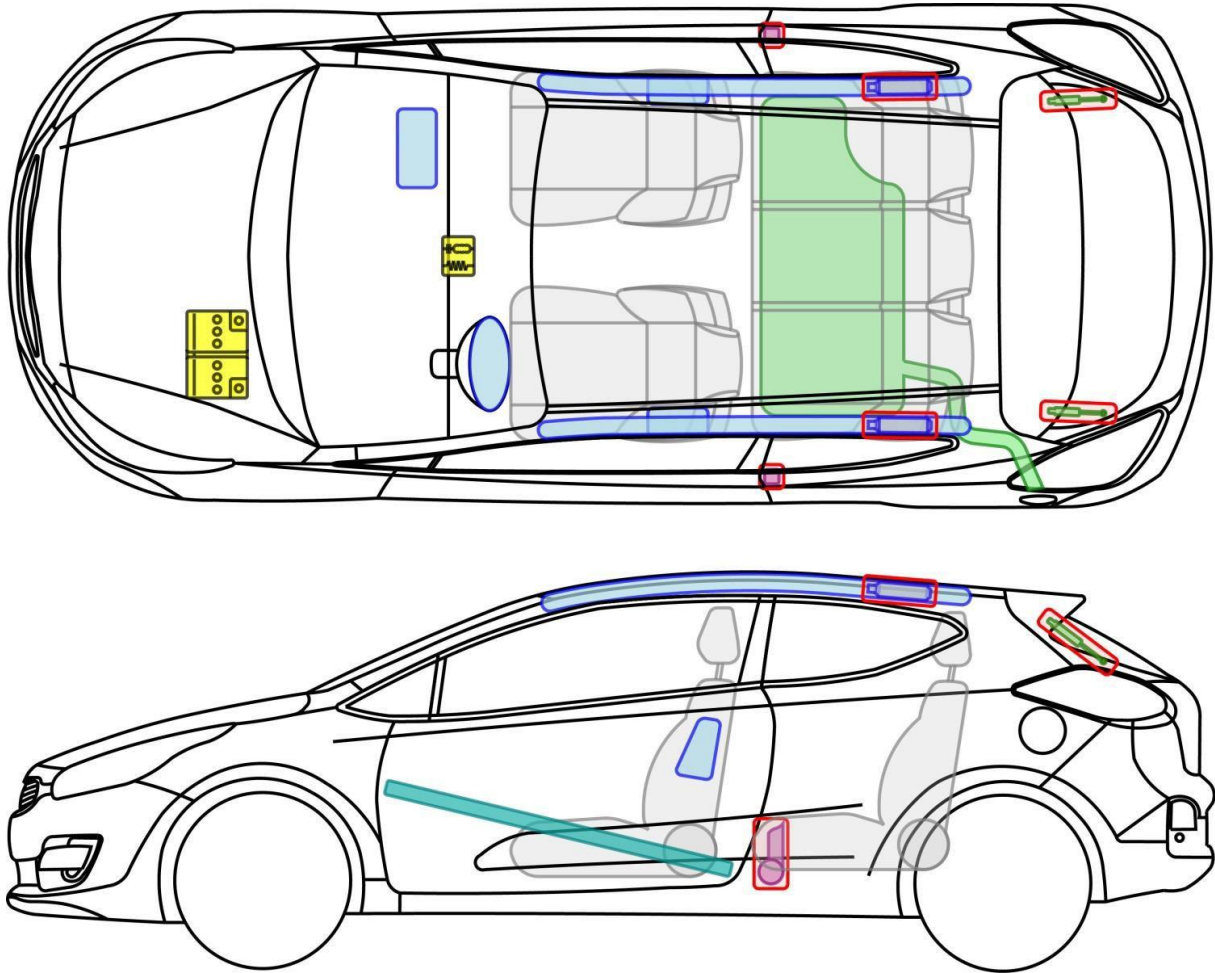

**Legende / Légende / Legenda**

|   |                                       |   |   |   |  |
|---|---------------------------------------|---|---|---|--|
|  | Airbag                                |  | 12V Batterie<br>12V Batterie<br>12V Batteria                            |  | Gasdruckdämpfer<br>Amortisseur à gaz<br>Ammortizzatore a gas         |
|  | Steuergerät<br>ECU<br>Centralina      |  | Karosserieverstärkung<br>Renfort de carrosserie<br>Rinforzo carrozzeria |  | Überrollschutz<br>Arceau de sécurité<br>Protezione anticappottamento |
|  | Gasgenerator<br>Gazogène<br>Gassogeno |  | Gurtstraffer<br>Prétensionneur de ceinture<br>Pretensionatore di carico |  | Kraftstofftank<br>Réservoir de carburant<br>Serbatoio di carburante  |









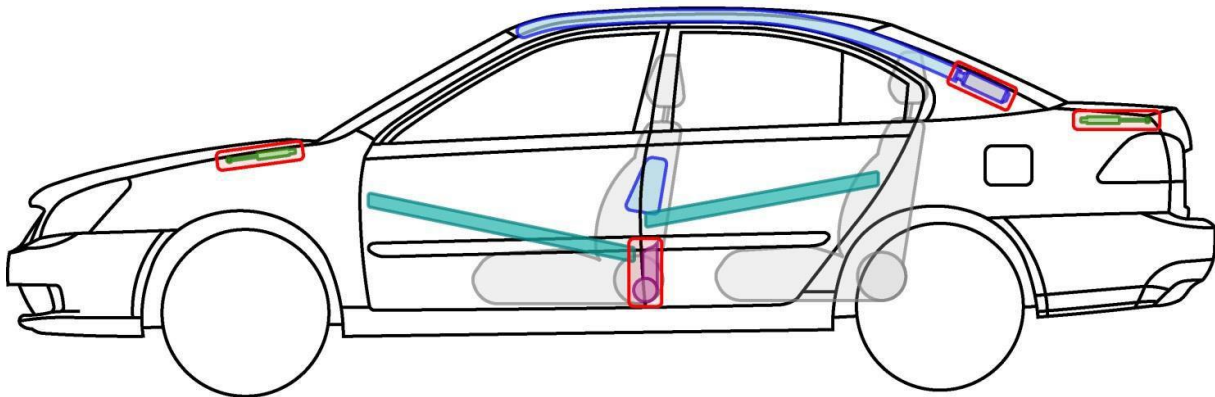
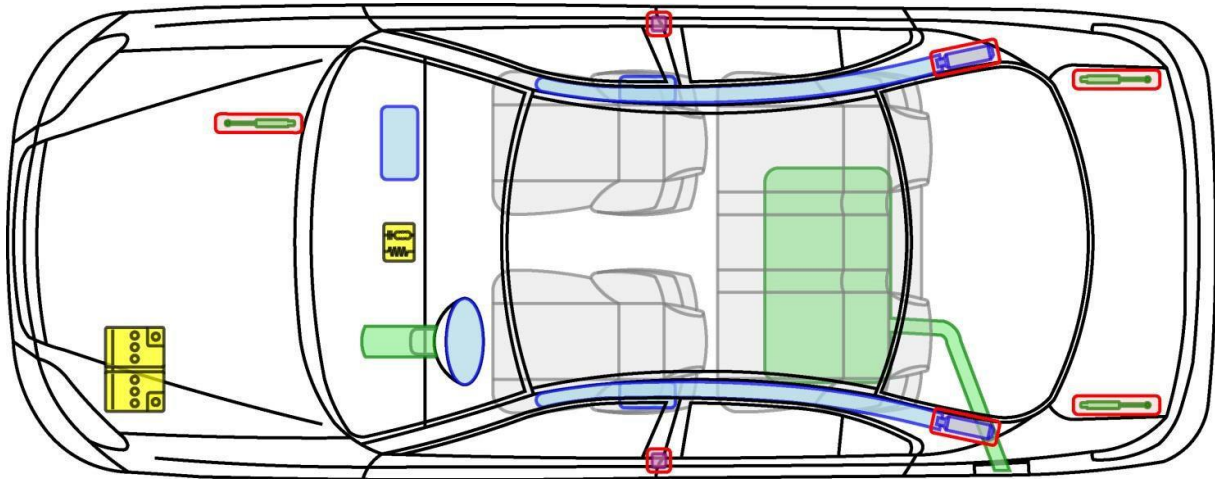





# Magentis (MG) ab/dès/dal 2006



### Legende / Légende / Legenda







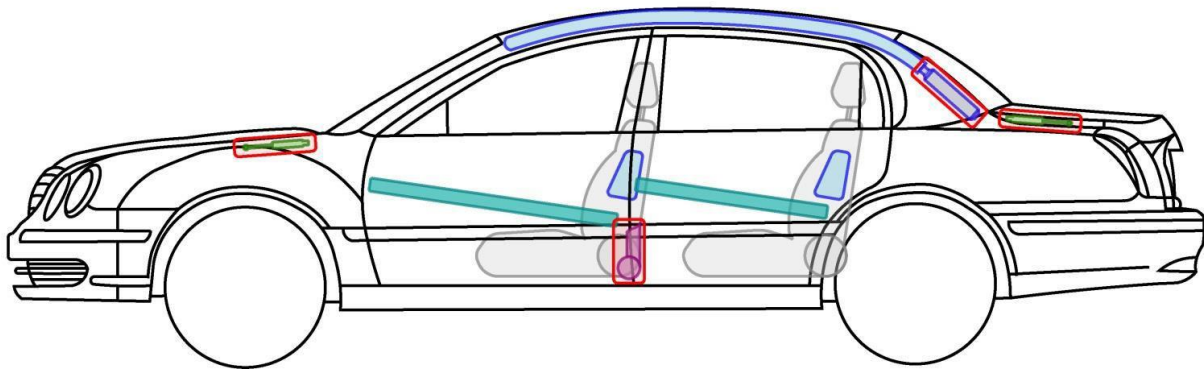
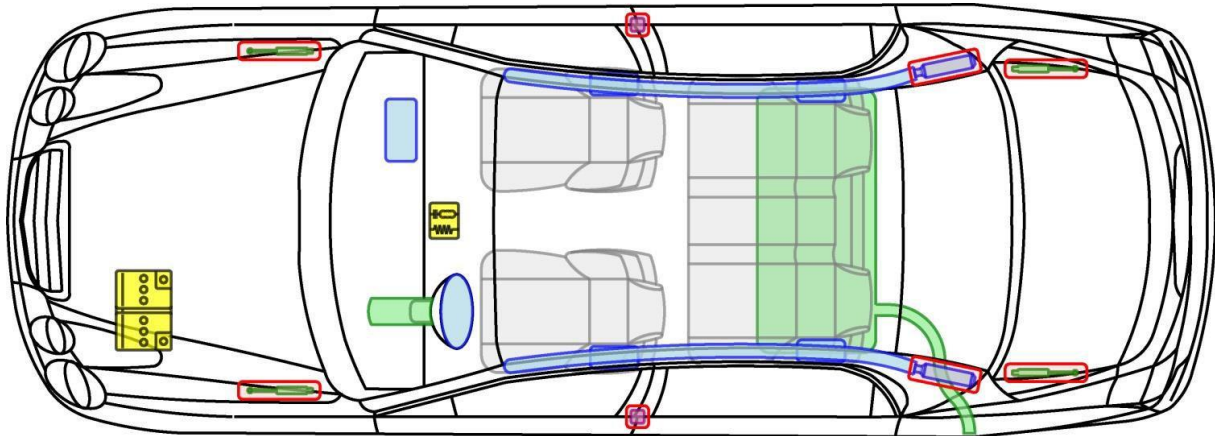

|   |                                       |   |   |   |  |
|---|---------------------------------------|---|---|---|--|
|  | Airbag                                |  | 12V Batterie<br>12V Batterie<br>12V Batteria                            |  | Gasdruckdämpfer<br>Amortisseur à gaz<br>Ammortizzatore a gas         |
|  | Steuergerät<br>ECU<br>Centralina      |  | Karosserieverstärkung<br>Renfort de carrosserie<br>Rinforzo carrozzeria |  | Überrollschutz<br>Arceau de sécurité<br>Protezione anticappottamento |
|  | Gasgenerator<br>Gazogène<br>Gassogeno |  | Gurtstraffer<br>Prétensionneur de ceinture<br>Pretensionatore di carico |  | Kraftstofftank<br>Réservoir de carburant<br>Serbatoio di carburante  |

Magentis



# Opirus (GH) ab/dès/dal 2003



| Legende / Légende / Legenda   |   |   |
|---|---|---|
|  | Airbag  |  12V Batterie<br>12V Batterie<br>12V Batteria                            |
|  | Steuergerät<br>ECU<br>Centralina  |  Gasdruckdämpfer<br>Amortisseur à gaz<br>Ammortizzatore a gas            |
|  | Gasgenerator<br>Gazogène<br>Gassogeno                                   |  Überrollschutz<br>Arceau de sécurité<br>Protezione anticappottamento    |
|  | Karosserieverstärkung<br>Renfort de carrosserie<br>Rinforzo carrozzeria |  Gurtstraffer<br>Prétensionneur de ceinture<br>Pretensionatore di carico |
|  | Kraftstofftank<br>Réservoir de carburant<br>Serbatoio di carburante     |   |

Opirus



# Optima (TF) ab/dès/dal 2012

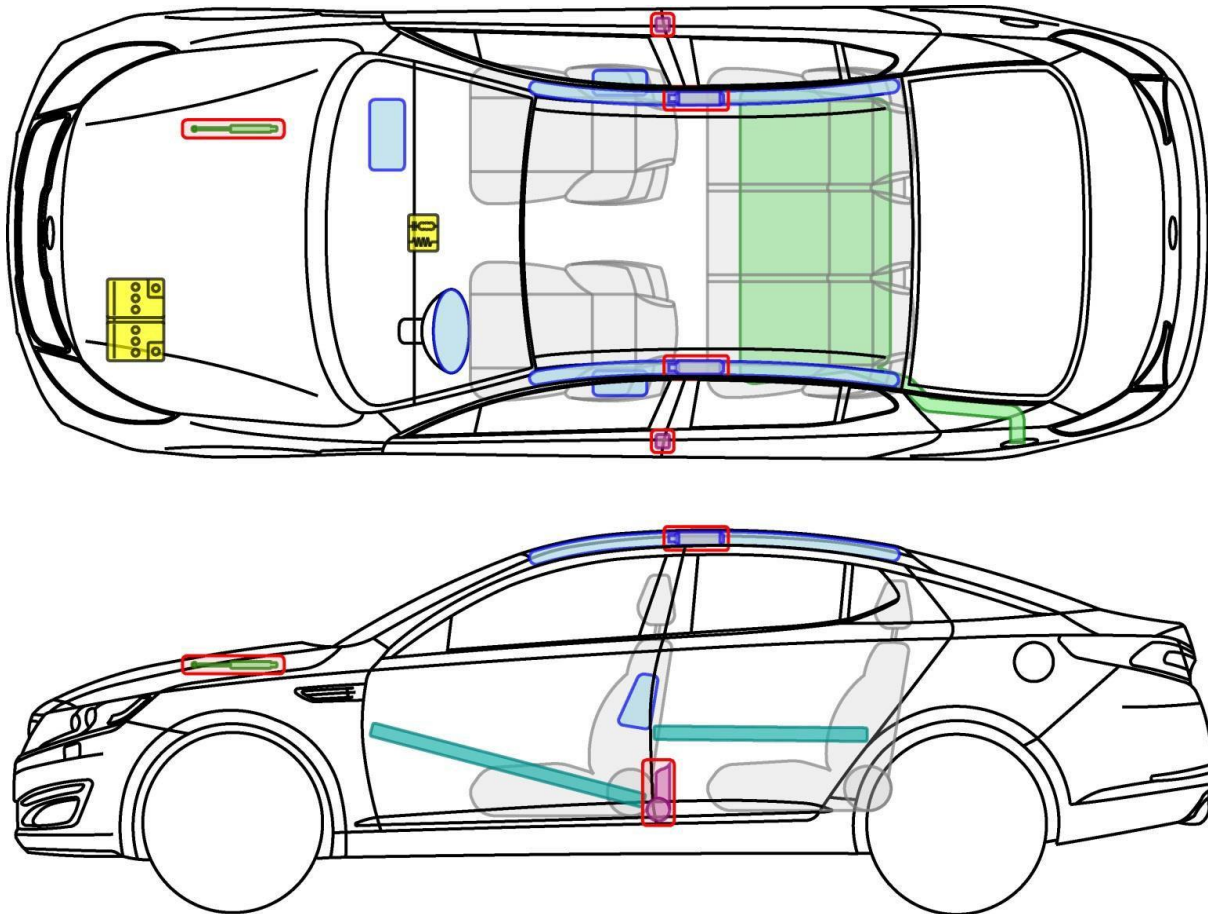

## Legende / Légende / Legenda



Airbag



12V Batterie  
12V Batterie  
12V Batteria



Gasdruckdämpfer  
Amortisseur à gaz  
Ammortizzatore a gas



Steuergerät  
ECU  
Centralina



Karosserieverstärkung  
Renfort de carrosserie  
Rinforzo carrozzeria



Überrollschutz  
Arceau de sécurité  
Protezione anticappottamento



Gasgenerator  
Gazogène  
Gassogeno



Gurtstraffer  
Prétensionneur de ceinture  
Pretensionatore di carico



Kraftstofftank  
Réservoir de carburant  
Serbatoio di carburante

Optima



# Optima (TF) ab/dès/dal 2012 Hybrid

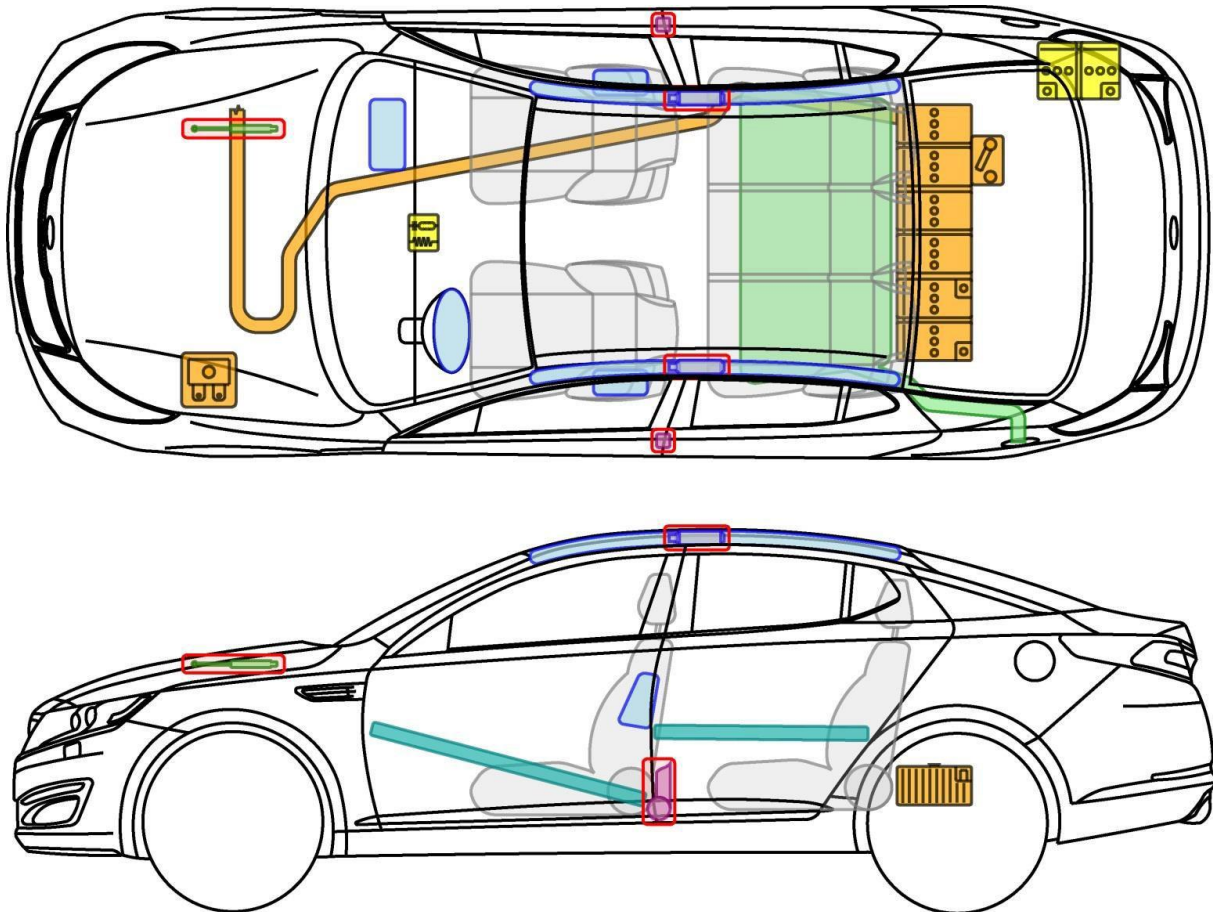

## Legende / Légende / Legenda

|   |   |   |   |   |   |
|---|---|---|---|---|---|
|  | Airbag  |  | 12V Batterie<br>12V Batterie<br>12V Batteria                                    |  | Gasdruckdämpfer<br>Amortisseur à gaz<br>Ammortizzatore a gas  |
|  | Steuergerät<br>ECU<br>Centralina  |  | Karosserieverstärkung<br>Renfort de carrosserie<br>Rinforzo carrozzeria         |  | Überrollschutz<br>Arceau de sécurité<br>Protezione anticappottamento  |
|  | Gasgenerator<br>Gazogène<br>Gassogeno                                   |  | Gurtstraffer<br>Prétensionneur de ceinture<br>Pretensionatore di carico         |  | Kraftstofftank<br>Réservoir de carburant<br>Serbatoio di carburante   |
|  | Hochvoltbatterie<br>Batterie haute tension<br>Batteria ad alta tensione |  | Hochvoltkomponenten<br>Composants haute tension<br>Componenti ad alto voltaggio |  | Hochvolt Trennstelle<br>Dispositif de coupure haute tension<br>Dispositivo di disinserimento alto voltaggio |







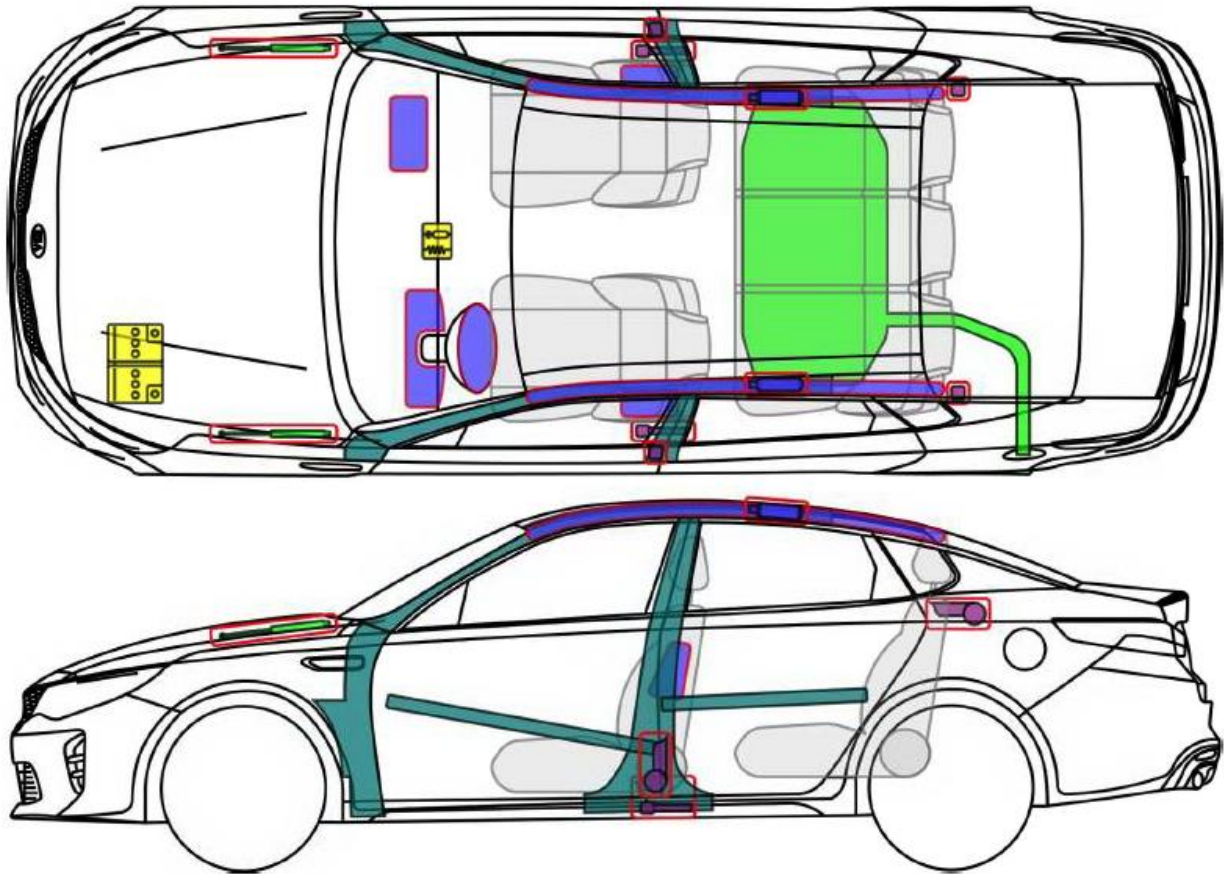

Optima



# Optima (JF) ab/dès/dal 2016



## Legende / Légende / Legenda

|   |                                       |   |   |   |  |
|---|---------------------------------------|---|---|---|--|
|  | Airbag                                |  | 12V Batterie<br>12V Batterie<br>12V Batteria                            |  | Gasdruckdämpfer<br>Amortisseur à gaz<br>Ammortizzatore a gas         |
|  | Steuergerät<br>ECU<br>Centralina      |  | Karosserieverstärkung<br>Renfort de carrosserie<br>Rinforzo carrozzeria |  | Überrollschutz<br>Arceau de sécurité<br>Protezione anticappottamento |
|  | Gasgenerator<br>Gazogène<br>Gassogeno |  | Gurtstraffer<br>Prétensionneur de ceinture<br>Pretensionatore di carico |  | Kraftstofftank<br>Réservoir de carburant<br>Serbatoio di carburante  |







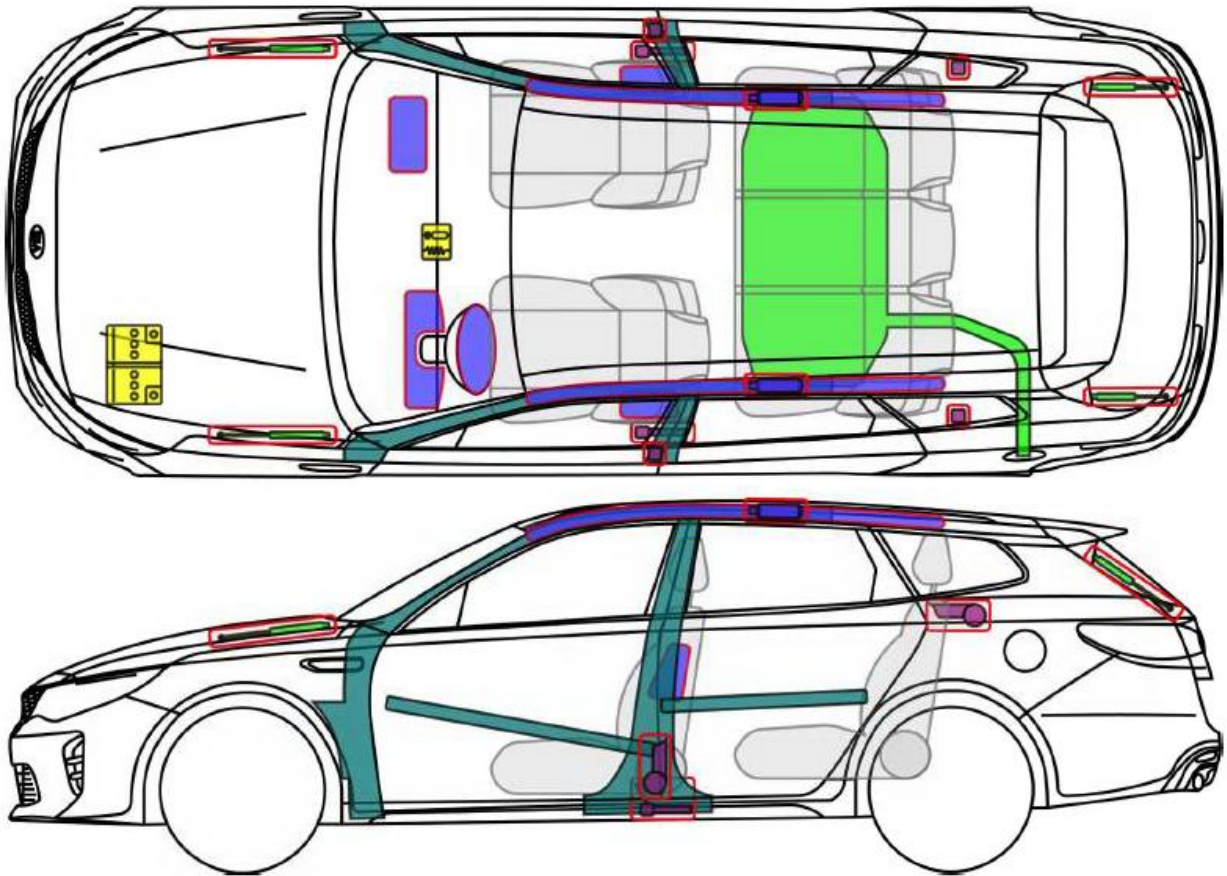

Optima



# Optima (JF) ab/dès/dal 2016 Sportswagon



## Legende / Légende / Legenda

|   |                                       |   |   |   |  |
|---|---------------------------------------|---|---|---|--|
|  | Airbag                                |  | 12V Batterie<br>12V Batterie<br>12V Batteria                            |  | Gasdruckdämpfer<br>Amortisseur à gaz<br>Ammortizzatore a gas         |
|  | Steuergerät<br>ECU<br>Centralina      |  | Karosserieverstärkung<br>Renfort de carrosserie<br>Rinforzo carrozzeria |  | Überrollschutz<br>Arceau de sécurité<br>Protezione anticappottamento |
|  | Gasgenerator<br>Gazogène<br>Gassogeno |  | Gurtstraffer<br>Prétensionneur de ceinture<br>Pretensionatore di carico |  | Kraftstofftank<br>Réservoir de carburant<br>Serbatoio di carburante  |







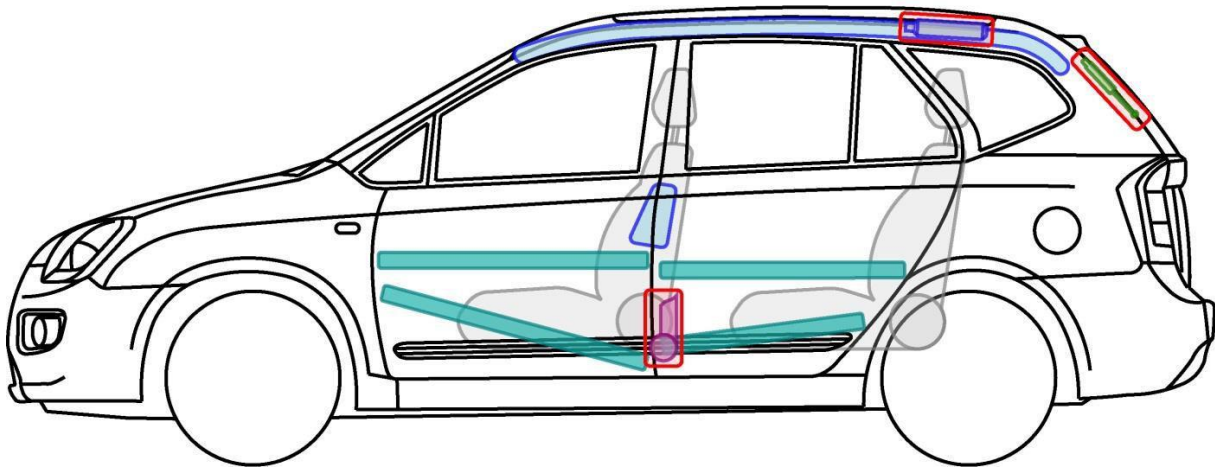
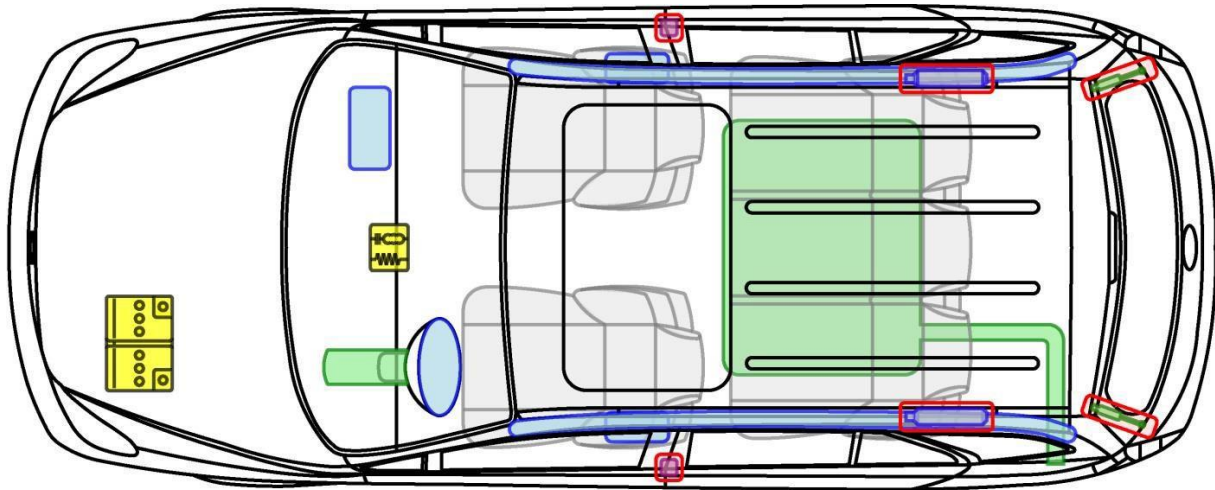

Optima



# Carens (UN) 2006-2013



### Legende / Légende / Legenda







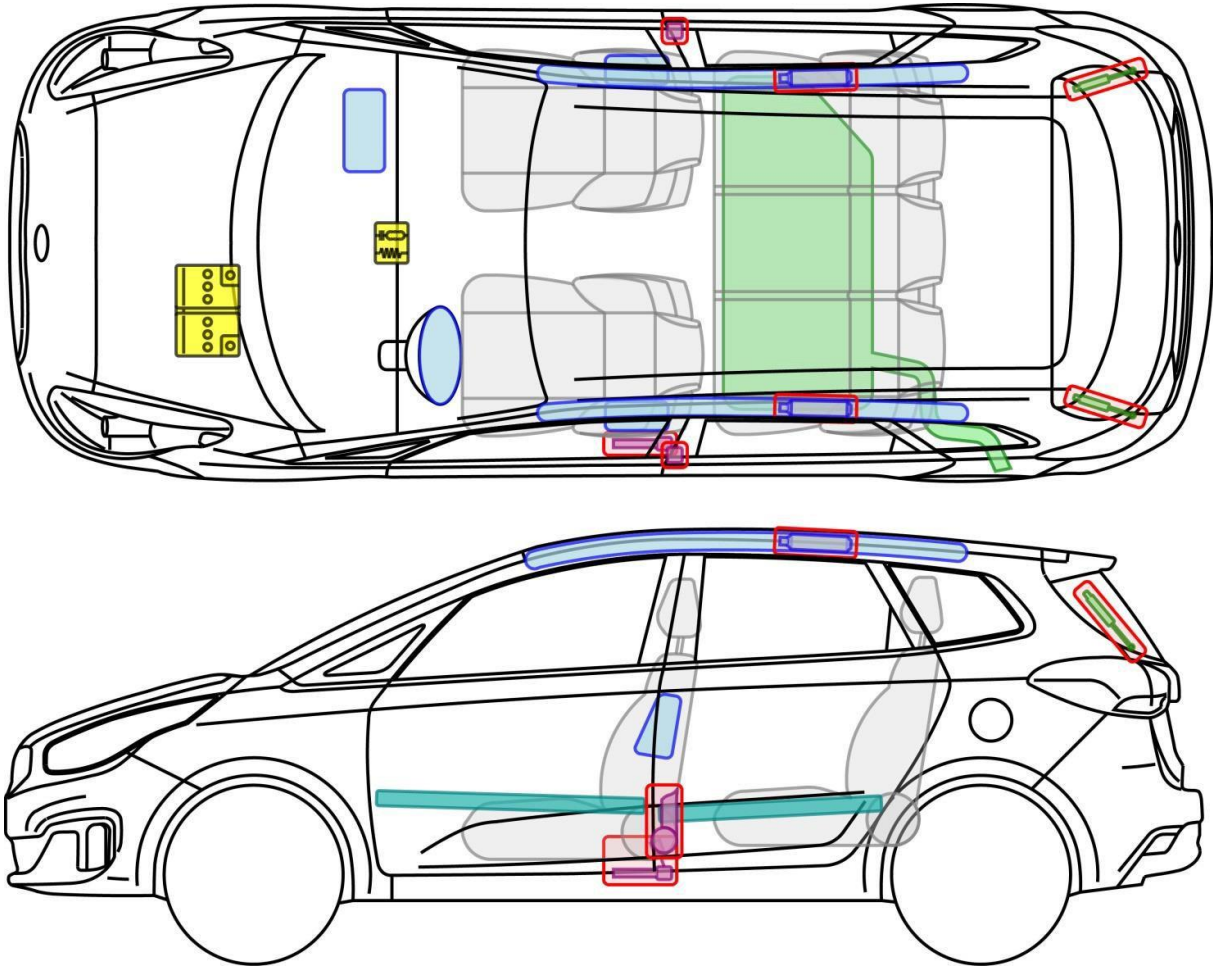

|   |                                       |   |   |   |  |
|---|---------------------------------------|---|---|---|--|
|  | Airbag                                |  | 12V Batterie<br>12V Batterie<br>12V Batteria                            |  | Gasdruckdämpfer<br>Amortisseur à gaz<br>Ammortizzatore a gas         |
|  | Steuergerät<br>ECU<br>Centralina      |  | Karosserieverstärkung<br>Renfort de carrosserie<br>Rinforzo carrozzeria |  | Überrollschutz<br>Arceau de sécurité<br>Protezione anticappottamento |
|  | Gasgenerator<br>Gazogène<br>Gassogeno |  | Gurtstraffer<br>Prétensionneur de ceinture<br>Pretensionatore di carico |  | Kraftstofftank<br>Réservoir de carburant<br>Serbatoio di carburante  |

Carens



# Carens (RP) ab/dès/dal 2013



| Legende / Légende / Legenda   |   |  |
|---|---|--|
|  | Airbag  |  |
|  | Steuergerät<br>ECU<br>Centralina  |  |
|  | Gasgenerator<br>Gazogène<br>Gassogeno                                   |  |
|  | 12V Batterie<br>12V Batterie<br>12V Batteria                            |  |
|  | Karosserieverstärkung<br>Renfort de carrosserie<br>Rinforzo carrozzeria |  |
|  | Gurtstraffer<br>Prétensionneur de ceinture<br>Pretensionatore di carico |  |
|  | Gasdruckdämpfer<br>Amortisseur à gaz<br>Ammortizzatore a gas            |  |
|  | Überrollschutz<br>Arceau de sécurité<br>Protezione anticapottamento     |  |
|  | Kraftstofftank<br>Réservoir de carburant<br>Serbatoio di carburante     |  |









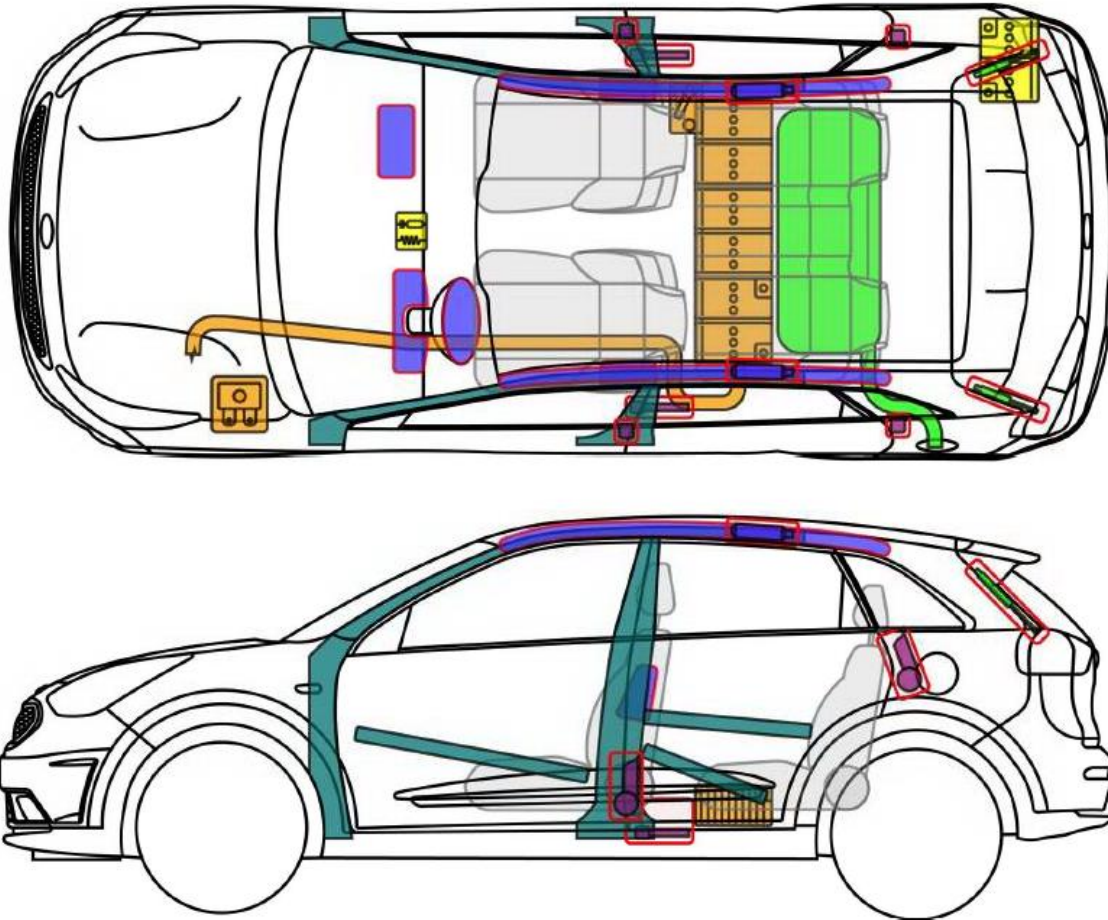



Carens





**Niro (DE)**  
**ab/dès/dal 2016**  
**Hybrid**



| Legende / Légende / Legenda   |   |   |   |  |   |
|---|---|---|---|--|---|
|  | Airbag  |  | 12V Batterie<br>12V Batterie<br>12V Batteria                                    |  | Gasdruckdämpfer<br>Amortisseur à gaz<br>Ammortizzatore a gas  |
|  | Steuergerät<br>ECU<br>Centralina  |  | Karosserieverstärkung<br>Renfort de carrosserie<br>Rinforzo carrozzeria         |   | Überrollschutz<br>Arceau de sécurité<br>Protezione anticappottamento  |
|  | Gasgenerator<br>Gazogène<br>Gassogeno                                   |  | Gurtstraffer<br>Prétensionneur de ceinture<br>Pretensionatore di carico         |   | Kraftstofftank<br>Réservoir de carburant<br>Serbatoio di carburante   |
|  | Hochvoltbatterie<br>Batterie haute tension<br>Batteria ad alta tensione |  | Hochvoltkomponenten<br>Composants haute tension<br>Componenti ad alto voltaggio |   | Hochvolt Trennstelle<br>Dispositif de coupure haute tension<br>Dispositivo di disinserimento alto voltaggio |







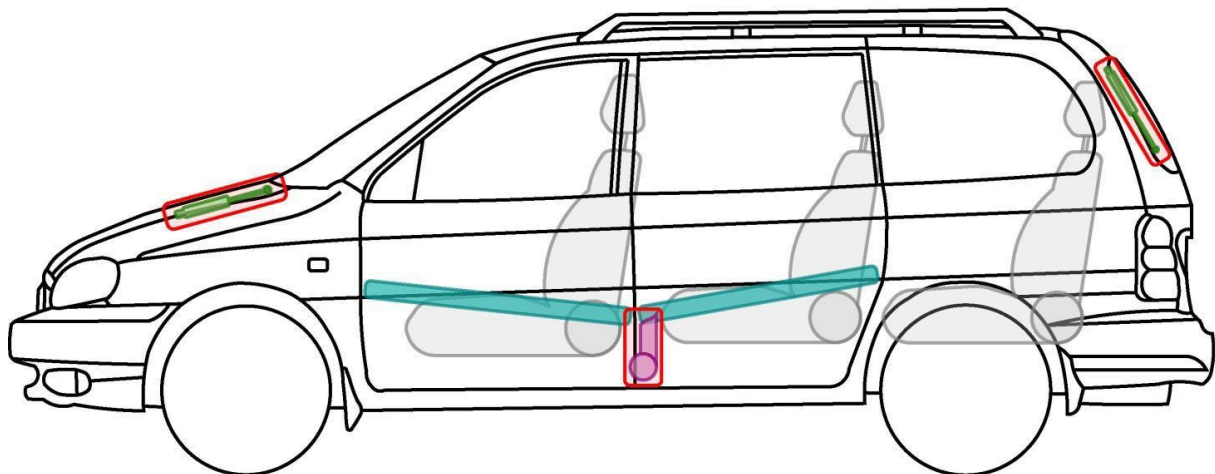
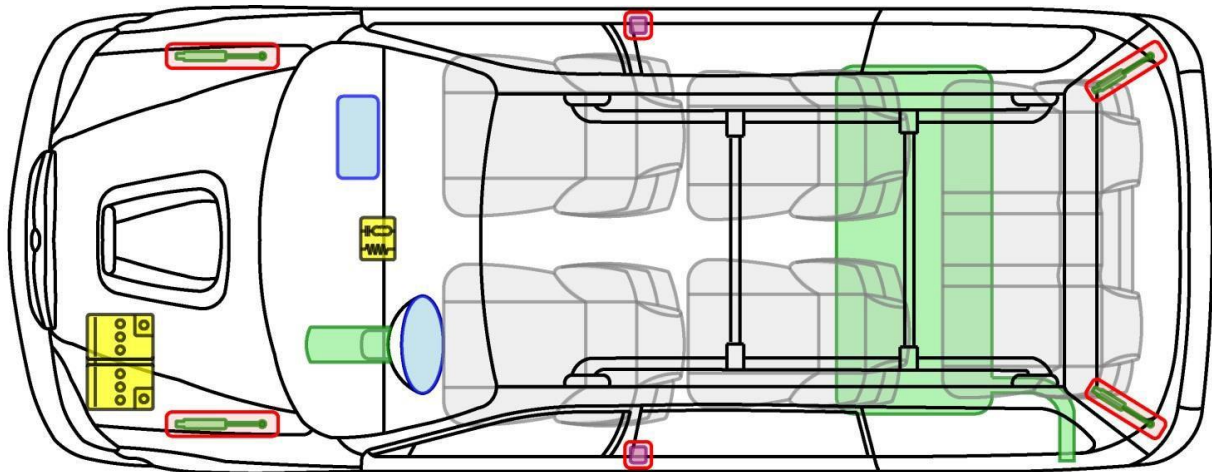

Niro



# Carnival (GQ) 1999-2006



### Legende / Légende / Legenda

|   |                                       |   |   |   |  |
|---|---------------------------------------|---|---|---|--|
|  | Airbag                                |  | 12V Batterie<br>12V Batterie<br>12V Batteria                            |  | Gasdruckdämpfer<br>Amortisseur à gaz<br>Ammortizzatore a gas         |
|  | Steuergerät<br>ECU<br>Centralina      |  | Karosserieverstärkung<br>Renfort de carrosserie<br>Rinforzo carrozzeria |  | Überrollschutz<br>Arceau de sécurité<br>Protezione anticappottamento |
|  | Gasgenerator<br>Gazogène<br>Gassogeno |  | Gurtstraffer<br>Prétensionneur de ceinture<br>Pretensionatore di carico |  | Kraftstofftank<br>Réservoir de carburant<br>Serbatoio di carburante  |

Carnival



# Carnival (VQ) ab/dès/dal 2006

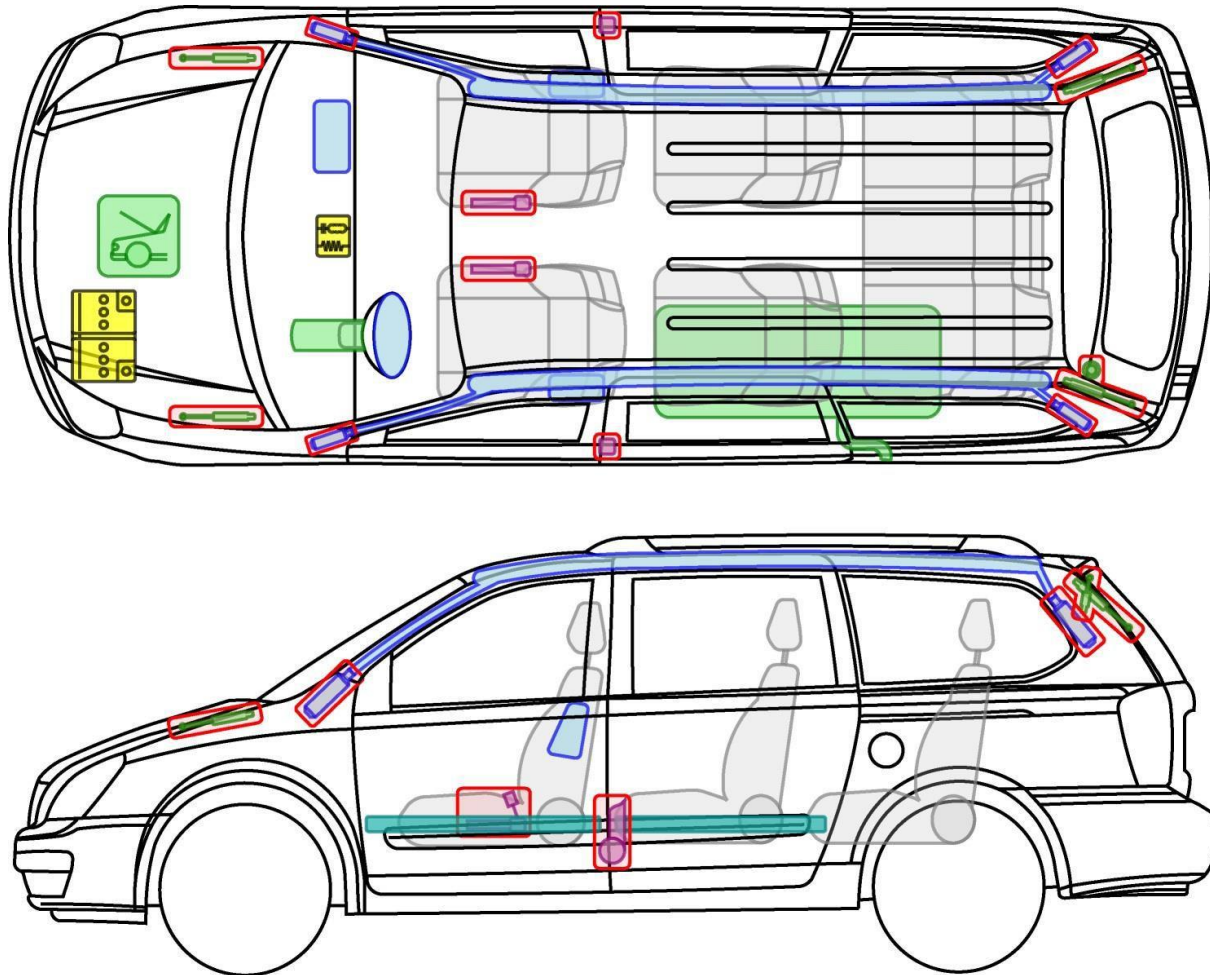

## Legende / Légende / Legenda

|   |                                       |   |   |   |  |
|---|---------------------------------------|---|---|---|--|
|  | Airbag                                |  | 12V Batterie<br>12V Batterie<br>12V Batteria                            |  | Gasdruckdämpfer<br>Amortisseur à gaz<br>Ammortizzatore a gas         |
|  | Steuergerät<br>ECU<br>Centralina      |  | Karosserieverstärkung<br>Renfort de carrosserie<br>Rinforzo carrozzeria |  | Überrollschutz<br>Arceau de sécurité<br>Protezione anticappottamento |
|  | Gasgenerator<br>Gazogène<br>Gassogeno |  | Gurtstraffer<br>Prétensionneur de ceinture<br>Pretensionatore di carico |  | Kraftstofftank<br>Réservoir de carburant<br>Serbatoio di carburante  |







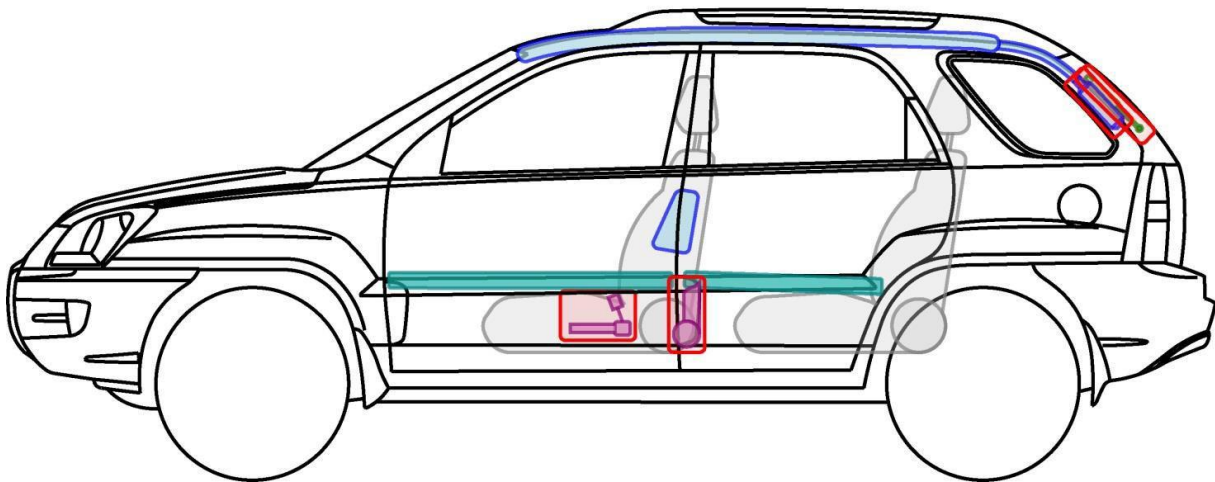
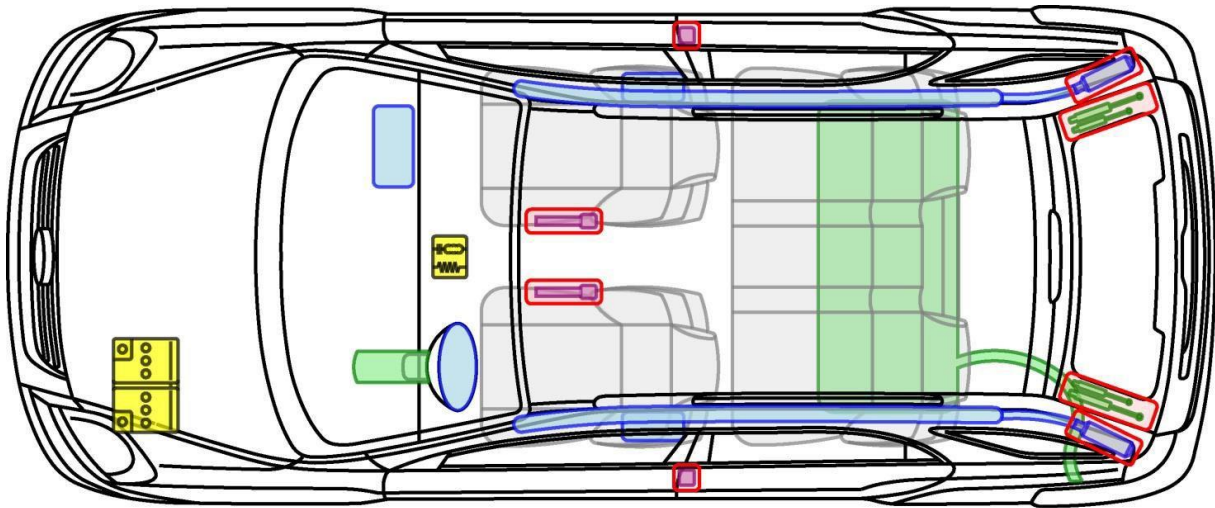

Carnival



# Sportage (KM/JES) 2004-2010



### Legende / Légende / Legenda

|   |                                       |   |   |   |  |
|---|---------------------------------------|---|---|---|--|
|  | Airbag                                |  | 12V Batterie<br>12V Batterie<br>12V Batteria                            |  | Gasdruckdämpfer<br>Amortisseur à gaz<br>Ammortizzatore a gas         |
|  | Steuergerät<br>ECU<br>Centralina      |  | Karosserieverstärkung<br>Renfort de carrosserie<br>Rinforzo carrozzeria |  | Überrollschutz<br>Arceau de sécurité<br>Protezione anticappottamento |
|  | Gasgenerator<br>Gazogène<br>Gassogeno |  | Gurtstraffer<br>Prétensionneur de ceinture<br>Pretensionatore di carico |  | Kraftstofftank<br>Réservoir de carburant<br>Serbatoio di carburante  |

Sportage



# Sportage (SL) ab/dès/dal 2010

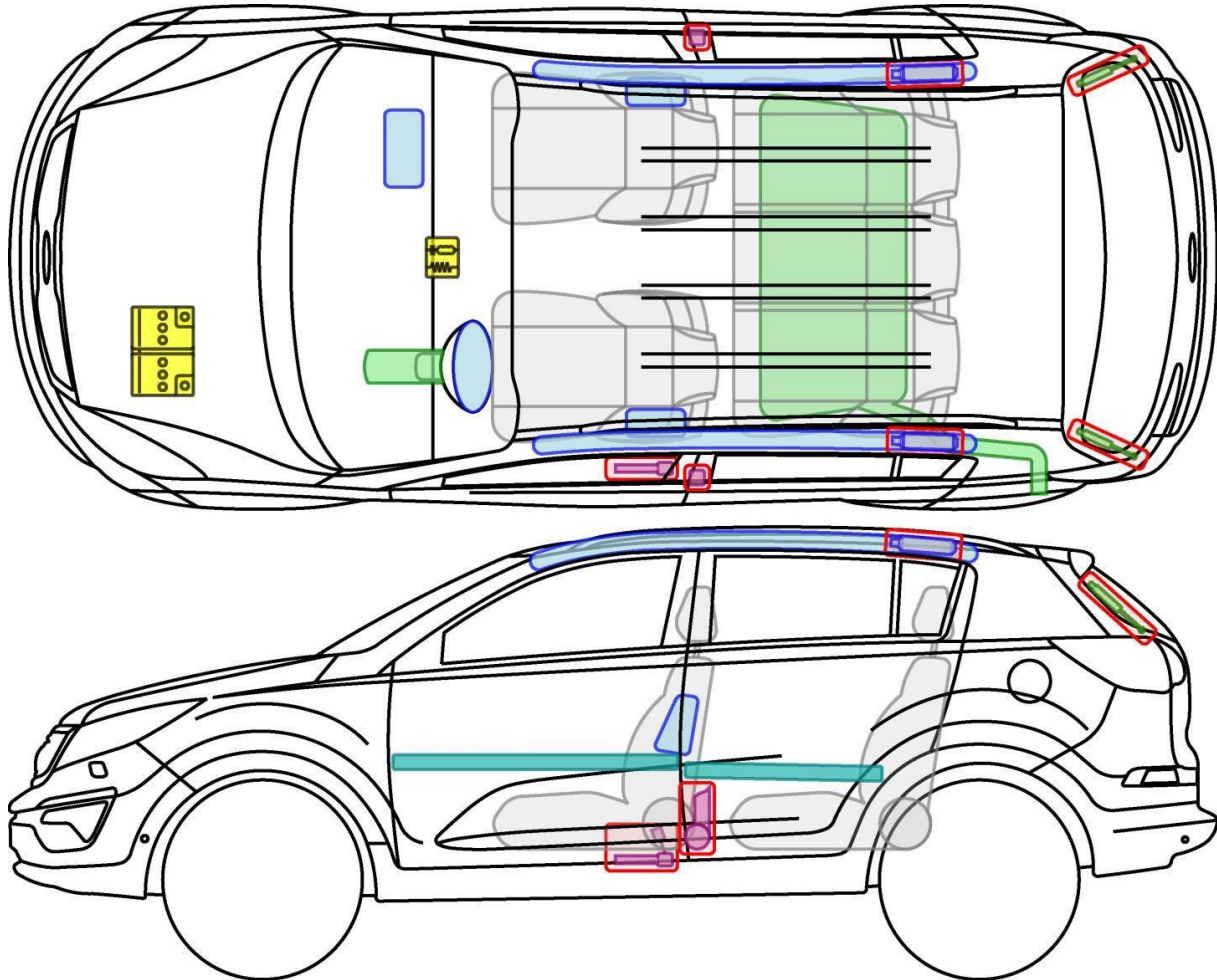

### Legende / Légende / Legenda

|  |                                       |  |   |  |   |
|--|---------------------------------------|--|---|--|---|
|  | Airbag                                |  | 12V Batterie<br>12V Batterie<br>12V Batteria                            |  | Gasdruckdämpfer<br>Amortisseur à gaz<br>Ammortizzatore a gas        |
|  | Steuergerät<br>ECU<br>Centralina      |  | Karosserieverstärkung<br>Renfort de carrosserie<br>Rinforzo carrozzeria |  | Überrollschutz<br>Arceau de sécurité<br>Protezione anticapottamento |
|  | Gasgenerator<br>Gazogène<br>Gassogeno |  | Gurtstraffer<br>Prétensionneur de ceinture<br>Pretensionatore di carico |  | Kraftstofftank<br>Réservoir de carburant<br>Serbatoio di carburante |







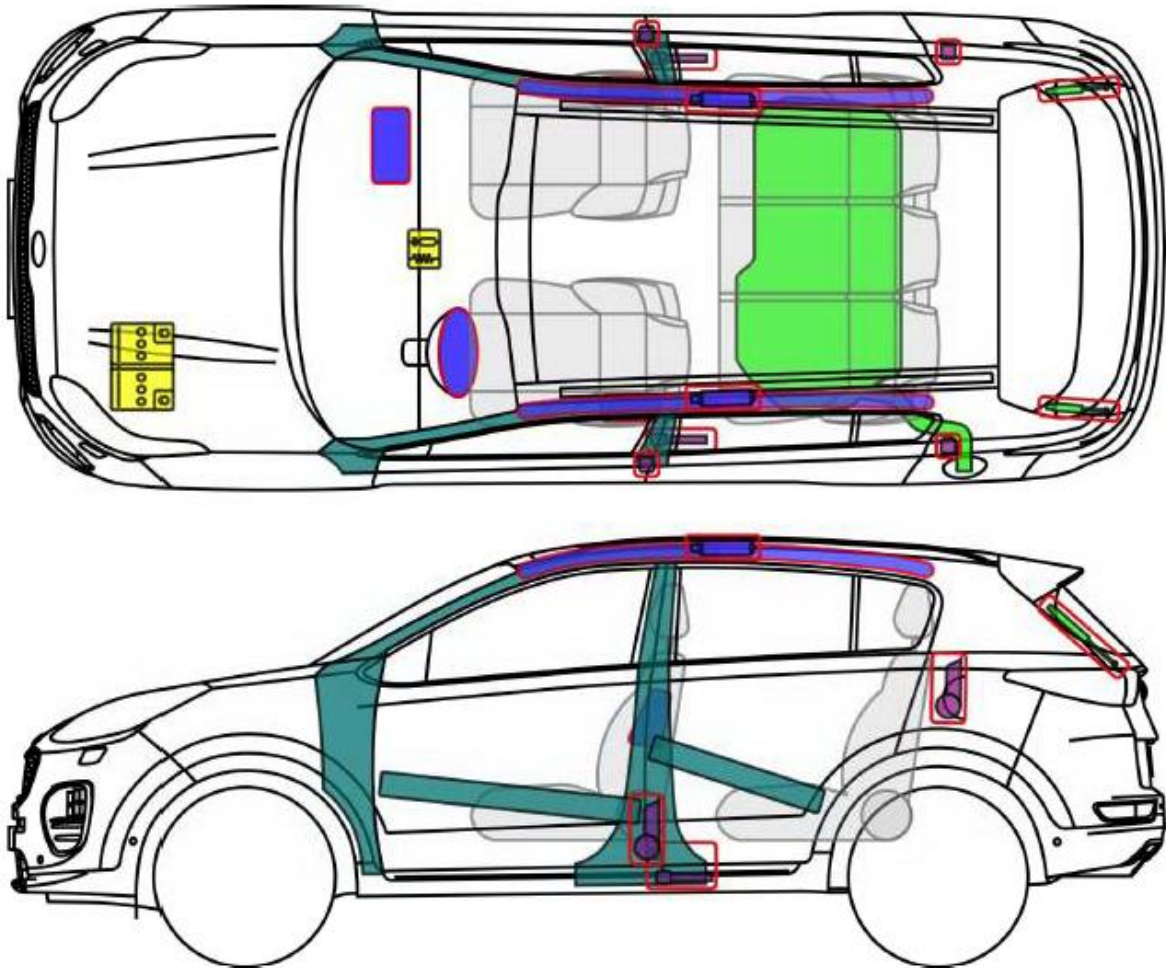

Sportage



# Sportage (QL) ab/dès/dal 2016



### Legende / Légende / Legenda

|   |                                       |   |   |   |   |
|---|---------------------------------------|---|---|---|---|
|  | Airbag                                |  | 12V Batterie<br>12V Batterie<br>12V Batteria                            |  | Gasdruckdämpfer<br>Amortisseur à gaz<br>Ammortizzatore a gas        |
|  | Steuergerät<br>ECU<br>Centralina      |  | Karosserieverstärkung<br>Renfort de carrosserie<br>Rinforzo carrozzeria |  | Überrollschutz<br>Arceau de sécurité<br>Protezione anticapottamento |
|  | Gasgenerator<br>Gazogène<br>Gassogeno |  | Gurtstraffer<br>Prétensionneur de ceinture<br>Pretensionatore di carico |  | Kraftstofftank<br>Réservoir de carburant<br>Serbatoio di carburante |







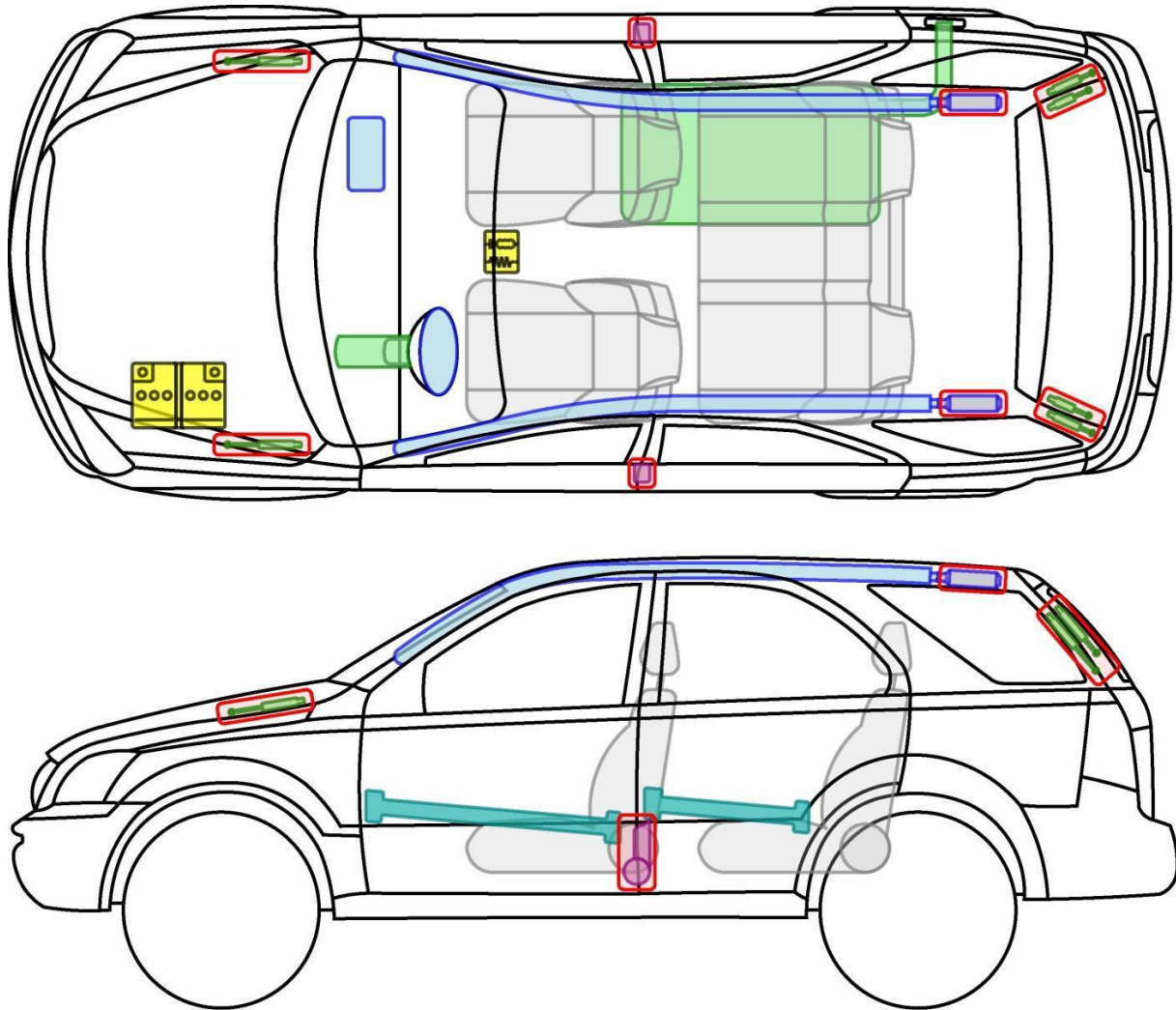

Sportage



# Sorento (BL) 2002-2006



## Legende / Légende / Legenda







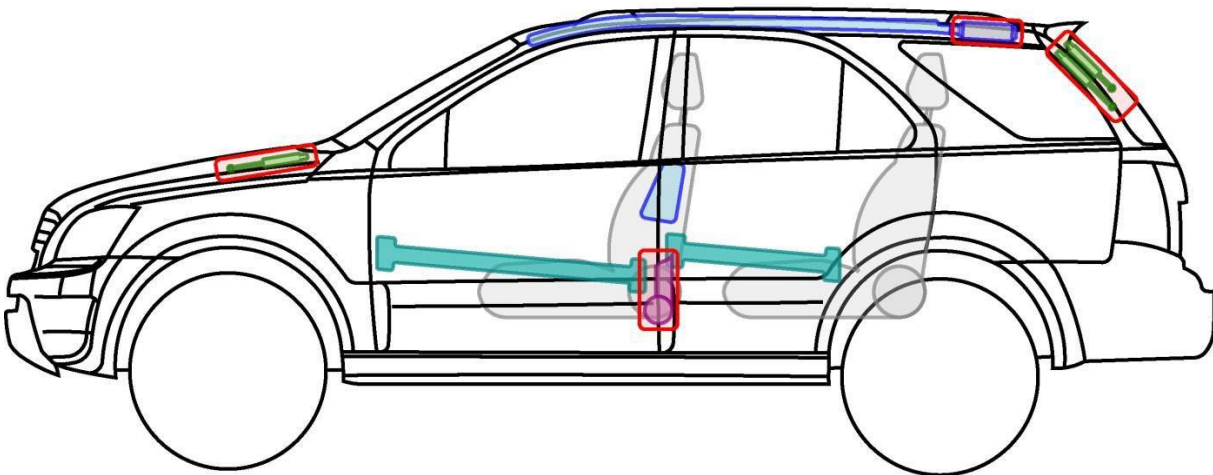
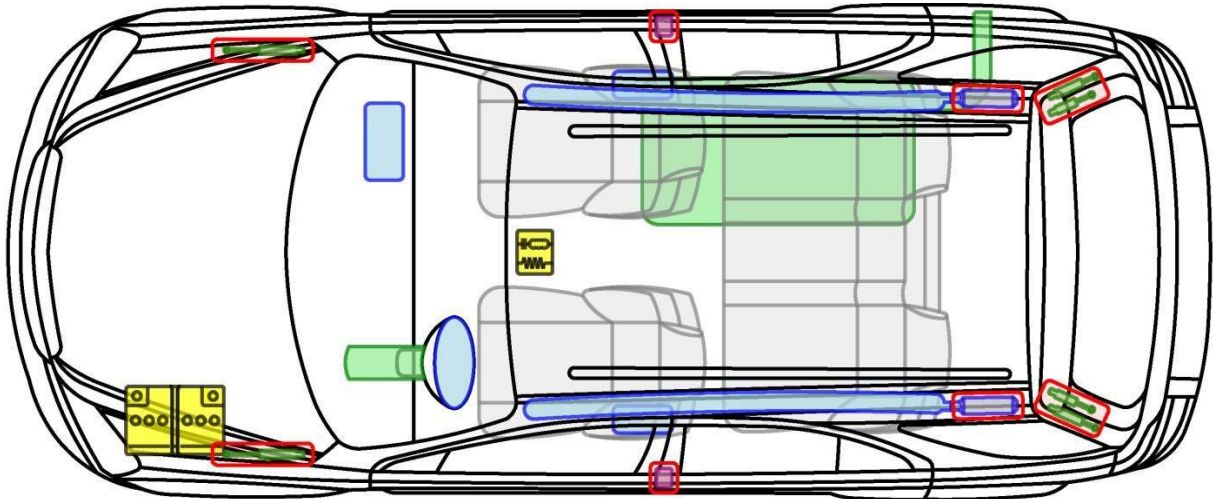

|   |                                       |   |   |  |   |
|---|---------------------------------------|---|---|--|---|
|  | Airbag                                |  | 12V Batterie<br>12V Batterie<br>12V Batteria                            |  | Gasdruckdämpfer<br>Amortisseur à gaz<br>Ammortizzatore a gas        |
|  | Steuergerät<br>ECU<br>Centralina      |  | Karosserieverstärkung<br>Renfort de carrosserie<br>Rinforzo carrozzeria |  | Überrollschutz<br>Arceau de sécurité<br>Protezione anticapottamento |
|  | Gasgenerator<br>Gazogène<br>Gassogeno |  | Gurtstraffer<br>Prétensionneur de ceinture<br>Pretensionatore di carico |   | Kraftstofftank<br>Réservoir de carburant<br>Serbatoio di carburante |

Sorento



# Sorento (BL) 2006-2009



| Legende / Légende / Legenda   |                                       |   |   |   |  |
|---|---------------------------------------|---|---|---|--|
|  | Airbag                                |  | 12V Batterie<br>12V Batterie<br>12V Batteria                            |  | Gasdruckdämpfer<br>Amortisseur à gaz<br>Ammortizzatore a gas         |
|  | Steuergerät<br>ECU<br>Centralina      |  | Karosserieverstärkung<br>Renfort de carrosserie<br>Rinforzo carrozzeria |  | Überrollschutz<br>Arceau de sécurité<br>Protezione anticappottamento |
|  | Gasgenerator<br>Gazogène<br>Gassogeno |  | Gurtstraffer<br>Prétensionneur de ceinture<br>Pretensionatore di carico |  | Kraftstofftank<br>Réservoir de carburant<br>Serbatoio di carburante  |

Sorento





# Sorento (XM) ab/dès/dal 2009

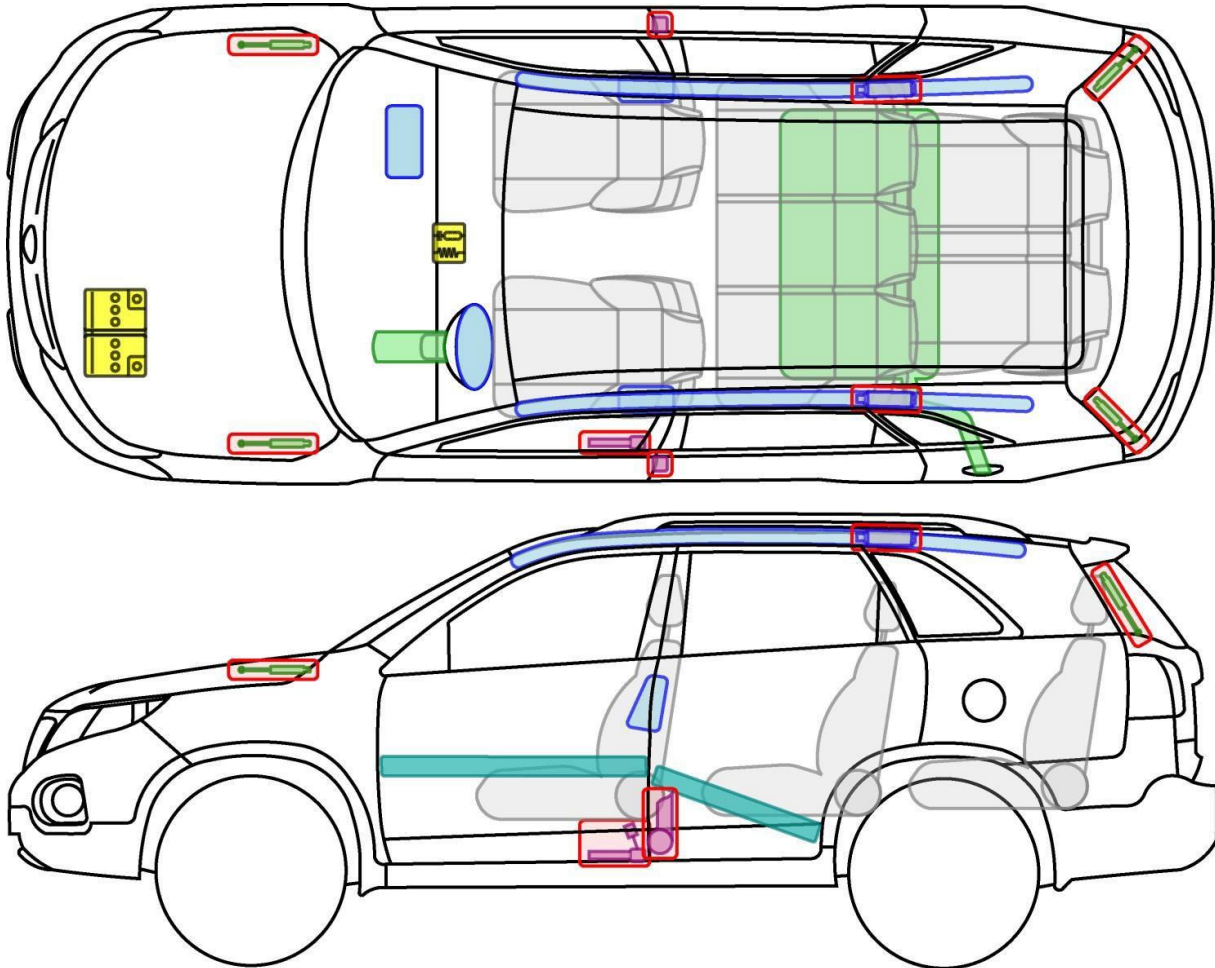

## Legende / Légende / Legenda

|   |                                       |   |   |   |  |
|---|---------------------------------------|---|---|---|--|
|  | Airbag                                |  | 12V Batterie<br>12V Batterie<br>12V Batteria                            |  | Gasdruckdämpfer<br>Amortisseur à gaz<br>Ammortizzatore a gas         |
|  | Steuergerät<br>ECU<br>Centralina      |  | Karosserieverstärkung<br>Renfort de carrosserie<br>Rinforzo carrozzeria |  | Überrollschutz<br>Arceau de sécurité<br>Protezione anticappottamento |
|  | Gasgenerator<br>Gazogène<br>Gassogeno |  | Gurtstraffer<br>Prétensionneur de ceinture<br>Pretensionatore di carico |  | Kraftstofftank<br>Réservoir de carburant<br>Serbatoio di carburante  |

Sorento



# Sorento (UM) ab/dès/dal 2014

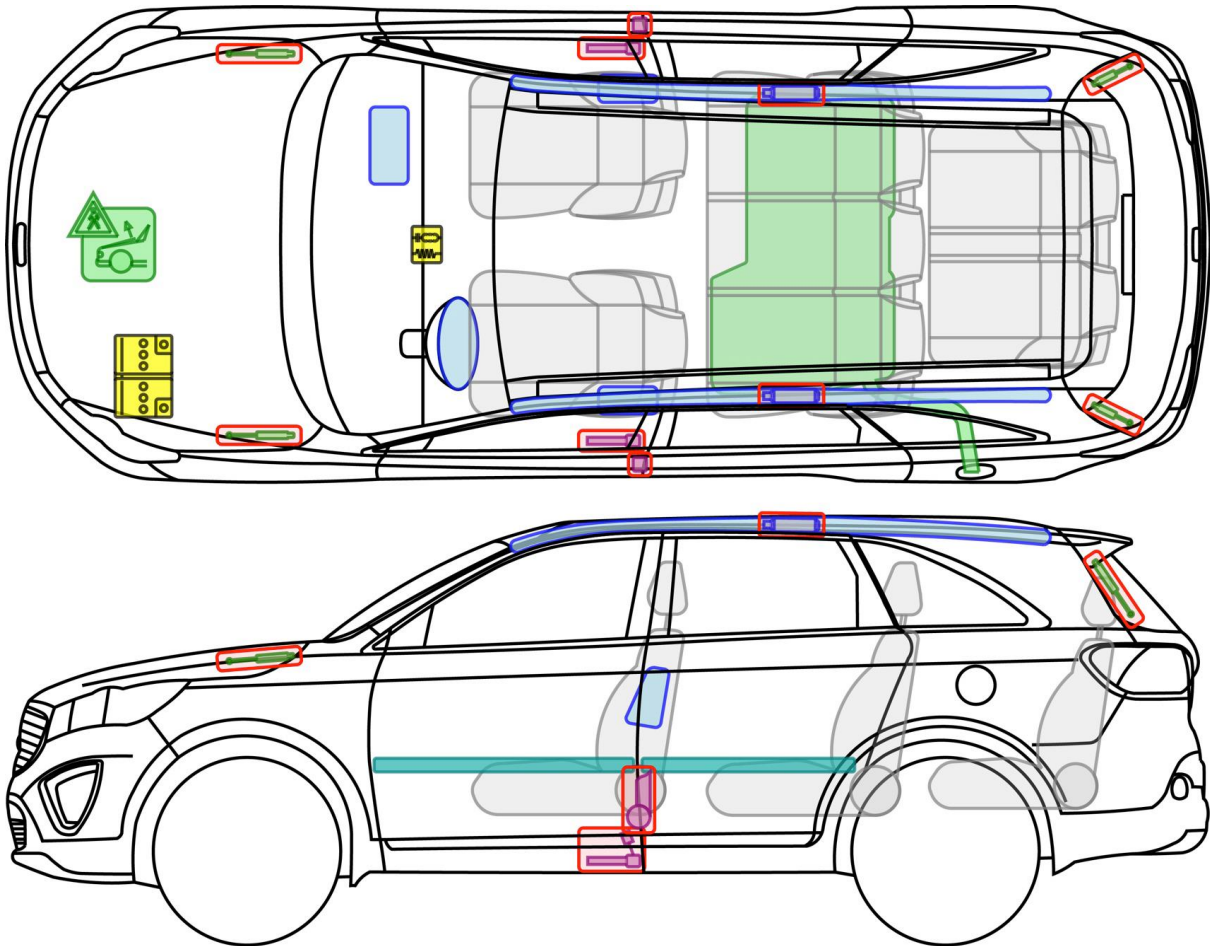

### Legende / Légende / Legenda

|   |   |   |   |   |   |
|---|---|---|---|---|---|
|  | Airbag  |  | 12V Batterie<br>12V Batterie<br>12V Batteria                            |  | Gasdruckdämpfer<br>Amortisseur à gaz<br>Ammortizzatore a gas                                    |
|  | Steuergerät<br>ECU<br>Centralina                                    |  | Karosserieverstärkung<br>Renfort de carrosserie<br>Rinforzo carrozzeria |  | Überrollschutz<br>Arceau de sécurité<br>Protezione anticappottamento                            |
|  | Gasgenerator<br>Gazogène<br>Gassogeno                               |  | Gurtstraffer<br>Prétensionneur de ceinture<br>Pretensionatore di carico |  | Fussgängerschutzsystem<br>Système de protection des piétons<br>Sistema di protezione dei pedoni |
|  | Kraftstofftank<br>Réservoir de carburant<br>Serbatoio di carburante |   |   |   |   |

Sorento